

LODE KING

BRILLIANCE SUPER-B
BRILLIANCE TRI-AXLE
BRILLIANCE TANDEM

RENOWN SUPER-B
RENOWN TRI-AXLE
RENOWN TANDEM

FORCELINE SUPER-B
FORCELINE TRI-AXLE
FORCELINE TANDEM



FLATBED TRAILERS



OWNER'S
MANUAL







QUALITY POLICY AND PHILOSOPHY

At Lode King Industries, it is our Quality objective to consistently meet or exceed our Customers expectations, and requirements, with regards to Reliability, Product Design, Performance, Fitness-for-use, Safety, Service and Value. In doing so we strive to exceed the Market Standards and build upon our reputation of providing a reliable and safe Quality product at competitive prices.

We are committed to achieving these Goals through the implementation of a Corporate Quality Assurance System designed to meet the requirements of the ISO 9001 Quality System Standard, combined with ethical business standards which focus on our Customers needs.

It is our Philosophy that the Goals and Objectives Stated above are attainable only through the active and controlled interfacing of all Departments from Sales, Administration, Engineering, Production to Servicing and therefore we encourage open communication between all Departments. Every Employee is charged with the responsibility of performing their daily functions using Quality and Safety as equal and primary priorities.

Manual updated October 8, 2020.

Lode King Industries
135 Canada St
Box 1146
Winkler, Manitoba, Canada
R6W 4B2

Phone: 1-204-325-4345
Fax: 1-204-325-5369
lodeking.com

COMPLIANCE PLATE

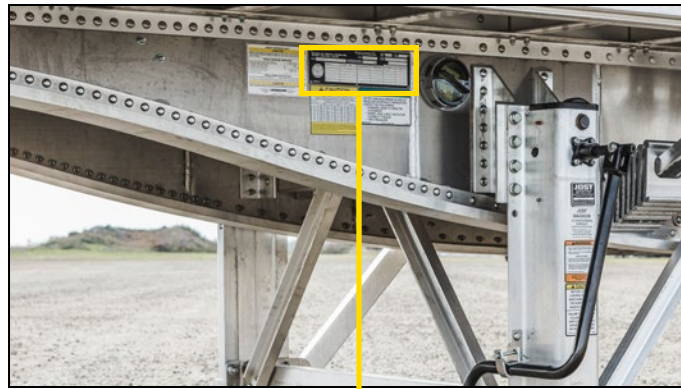

AXLES (IN ORDER FROM FRONT) ESSIEUX (AFIN DE L'AVANT)		GAWR / PNBE KG LB		TIRES PNEUS	RIMS JANTES	COLD INFLATION PRESSURE PRESSION DE GONFLAGE A FROID	
						KPA	PSI
				()			()
				()			()
				()			()
				()			()

LODE KING
 DIVISION OF TRIPLE E CANADA LTD. WINKLER, MANITOBA, CANADA

DATE OF MANUFACTURE: MONTH _____ YEAR _____
 DATE DE SA FABRICATION: MOIS _____ ANNEE _____

TYPE _____ GVWR _____ KG _____ LB _____
 PNBV _____

V.I.N. _____
 N.I.V. _____

THIS VEHICLE CONFORMS TO ALL APPLICABLE U.S. FEDERAL MOTOR VEHICLE SAFETY STANDARDS IN EFFECT ON THE DATE OF MANUFACTURE SHOWN ABOVE.

1JA000550

The compliance plate is located on the road side of the unit near the landing gear as shown in the photograph. The compliance plate verifies compliance with all applicable Canadian Motor Vehicle Safety Standards (CMVSS), and US Federal Motor Vehicle Safety Standards (FMVSS), and records the following information.

1. **DATE OF MANUFACTURE**

2. **VEHICLE IDENTIFICATION NUMBER (V.I.N.)**

A 17-character serial number as prescribed by Transport Canada regulation.

3. **GROSS AXLE WEIGHT RATING (G.A.W.R.)**

Gross axle weight rating is the total capacity for each individual axle at the tire ground “interface”. It reflect the weakest link in the entire suspension system, whether it be brakes, springs, axles, wheels, or tires.

4. **GROSS VEHICLE WEIGHT RATING (G.V.W.R.)**

The G.V.W.R. for semi-trailers is the sum of the trailer tare weight and its maximum payload. On a semi trailer the sum of all G.A.W.R. does not equal the G.V.W.R. The G.V.W.R. is a measure of the structural capacity of the trailer frame and does not reflect the legal highway weights.

5. **VEHICLE TYPE**

The type of vehicle is to be shown using the following abbreviation for a semi-trailer: TRA/REM.

6. **NATIONAL SAFETY MARK**

The maple leaf logo displays the unique manufacturers code of Lode King Industries. By affixing this logo Lode King is certifying that the trailer is in full compliance with all Transport Canada regulations in effect at its date of manufacture.

NEW VEHICLE LIMITED WARRANTY

LODE KING INDUSTRIES, A DIVISION OF TRIPLE E CANADA LTD.

This New Vehicle Limited Warranty is the sole and only warranty applicable to your new Lode King Trailer. This Warranty is issued by Lode King Industries, a division of Triple E Canada Ltd. only, which is the manufacturer of your Trailer. Lode King Industries uses or may use a variety of trade and/or division names in marketing or advertising its products. Lode King Industries, a division of Triple E Canada Ltd. is referred to throughout this Warranty as “Lode King.”

1. **Basic Warranty Coverage.** Subject to the conditions and limitations set forth in this Warranty, Lode King warrants to the first retail purchaser (and, for greater certainty, this Warranty may not be transferred) of the Trailer from an authorized Lode King dealer that all parts and components of the Trailer manufactured and installed by Lode King will be free from defects in materials and workmanship in the course of Normal Use (as defined below) for the applicable time period below:

Container chassis and special trailers One year
Flat and grain trailers Three years
Flat deck trailers – main beams only Five years

after the date of purchase by the first retail purchaser of the Trailer from an authorized Lode King dealer. Defective parts covered by this Warranty shall be repaired or replaced at the election of Lode King upon return of the Trailer to an authorized Lode King service center or dealer. In addition, Lode King will pay the cost of labor by an authorized Lode King service center or dealer to remove, repair and/or replace defective parts covered by this Warranty. “Normal Use” means operation of the Trailer on paved roads in Canada and the USA for purposes consistent with the design and intended use of such Trailer.

2. **Structural Warranty Coverage.** Subject to the conditions and limitations set forth in this Warranty, Lode King warrants to the first retail purchaser of the Trailer from an authorized Lode King dealer that the main structural beams (the “Beams”) of the Trailer will be free of defects in materials and workmanship in the course of Normal Use for a period of Five years after the date of purchase by the first retail purchaser of

the Trailer from an authorized Lode King dealer. For purposes of structural warranty coverage, Beams shall include only the main steel beams and all steel or aluminum members welded to the Beams. All other items are covered solely by the Basic Coverage of this Warranty. Defective Beams covered by this Warranty shall be repaired or replaced at the election of Lode King upon return of the Trailer to an authorized Lode King service center or dealer. In addition, Lode King will pay the cost of labor by an authorized Lode King service center or dealer to remove, repair and/or replace such defective Beams covered by this Warranty.

3. **Normal Wear Items.** The foregoing Warranties do not apply to or cover items which, by virtue of their materials or function, wear out, are expended or deteriorate with the passage of time, use or the accumulation of operating time, such as, but not limited to, springs, seals, hoses, lamp bulbs, brake friction items or materials, tires and bushings. The foregoing Warranties do not apply to or cover alignments or adjustments to the Trailer in the course of Normal Use.

4. **Component Warranties.** Lode King procures many items of equipment, components, parts and sub-assemblies of the Trailer (referred to in this Warranty as a “Component”) from other manufacturers. Some of these manufacturers offer their own separate warranty (and in some cases warranty extension programs) covering their respective Component(s). The foregoing Warranties exclude any and all Component(s) covered by a separate manufacturer’s warranty or extension program. Lode King assigns to the first retail purchaser of the Trailer from an authorized Lode King dealer each and every such separate Component warranty as the sole, exclusive and only warranty in respect of such Component(s). Lode King provides no other warranty coverage for any such Component(s). The rights of a purchaser of a Lode King Trailer under warranties covering such Component(s) may be conditioned upon or limited by the specific terms and conditions of such separate warranties. Information on separate Component warranties and registration for such warranties from Component manufacturers may be found in the Owner’s Manual.

5. **Exclusions From Warranty.** The Warranties exclude and do not cover to any Trailer which has been altered outside of the Lode King factory in a way which in Lode King's judgment affects its stability, operation, durability or reliability or which has been subject to abuse, misuse, neglect, accident, structural or other modification, improper loading, unloading or carriage of improperly distributed loads, corrosive materials or cargo, or which has been subjected to strains or impacts not generally experienced in lawful operation in Normal Use on properly maintained public roads. The Warranties exclude and do not cover and do not apply to loss or damages resulting from exceeding gross vehicle weight limits, gross axle weight limits or concentrated loads the concentration or distribution of which causes loss or damage to the Trailer. The Warranties exclude and do not cover any Trailer that has been shipped to or operated at a location outside of the Canada or the USA. The Warranties exclude and do not cover damage, defects or loss resulting from failure to properly and frequently clean or repair damage to paint, failure to provide regular maintenance and/or service (including as required or recommended by the Owner's Manual), adjustments, tune ups, alignments, road service or failure to protect the Trailer from further damage if any initial indication of damage has occurred. Loss or damage resulting from, aggravated by or made worse by continued operation of the Trailer after an initial failure is excluded from and not covered by the Warranties, even though the initial failure may be covered by the Warranties. The floor of a Trailer is not covered where the failure or defect is caused in part by improper care, including but not limited to, exceeding load, loading or forklift ratings, improper or ill-advised placement and/or concentration of loads, swelling, shrinkage, twisting, cracking resulting in part from water absorption and/or drying. The Warranties exclude and do not cover any parts, components or devices not installed by Lode King in the course of original manufacture of a Trailer. Operation of a Trailer on roads with loose sand, gravel and/or stones will result in chipping and/or abrasion of painted surfaces and/or corrosion or discoloration of aluminum and steel. Paint chipping and/or abrasion, paint coloration or consistency, aluminum or steel corrosion and other surface rusting or discoloration resulting from road conditions, abrasives, salt, de-icing agents, improper or inadequate cleaning or use of cleaning agents other than soap and water, or improper storage is excluded from and not

covered by the Warranties. The Warranties exclude and do not cover loss or damage resulting from accidents or failure to properly maintain in accordance with regularly-scheduled maintenance recommendations of both Lode King and any manufacturers of Components. The Warranties do not cover loss, defects or failures resulting from exposure to extreme conditions, including extremely cold weather. The Warranties exclude and do not cover defects or failure resulting from accident, collision, vandalism, fire or flood, or costs incurred in towing, transporting or presenting your Trailer for repair under the Warranties.

Your Warranties exclude and do not provide coverage for special, consequential or incidental damages, such as the loss of use of the Trailer, loss of time, inconvenience, expenses, transportation to and from the dealer or manufacturing location, bus, taxi or air fares, telephone, travel, rental vehicle, overnight accommodations, loss or damage to personal property, commercial loss of cargo or shipping revenue, loss of income, or other special, incidental or consequential damages or expenses.

TO THE MAXIMUM EXTENT PERMITTED BY APPLICABLE LAW, THE EXPRESS WARRANTIES STATED HEREIN ARE THE SOLE AND ONLY WARRANTIES ISSUED BY LODE KING IN RESPECT OF YOUR TRAILER, AND LODE KING HEREBY EXPRESSLY DISCLAIMS ALL OTHER WARRANTIES, INCLUDING IMPLIED WARRANTIES OF MERCHANTABILITY OR WARRANTIES OF FITNESS FOR ANY PARTICULAR PURPOSE. NEITHER YOUR DEALER NOR ANY OTHER PERSON IS AUTHORIZED TO CREATE OR IMPLY ANY OTHER WARRANTY ON BEHALF OF LODE KING BEYOND THOSE EXPRESSED HEREIN. THE WARRANTIES EXPRESSLY EXCLUDE LIABILITY FOR SPECIAL, INCIDENTAL OR CONSEQUENTIAL DAMAGES.

6. **Obtaining Warranty Repairs.** To obtain repairs under these Warranties, you must at your own cost present your Trailer to an authorized service center or dealer during normal business hours and provide a written list of claimed warranted defects. If requested, you may be required to provide records showing that the Trailer has been maintained as required or recommended by the Owner's Manual and is not subject to exclusions or limitations set forth in this Warranty. If a repair is covered by the Warranty (as determined by Lode King) and an authorized Lode King service center

or dealer is unwilling or unable to make the repair, Lode King may cause those repairs to be made at another location. Refusal to comply with Lode King's request to transport the Trailer to another service center at Lode King's cost and expense for mileage may void Warranty coverage for requested repairs.

7. **Questions about Warranty Service.** You may contact the Lode King Warranty Department at its number 1-204-325-4345 or mailing address: Box 1146, Winkler, MB, R6W 4B2 if you have a question about these Warranties, you need assistance in locating an authorized service center or dealer or if you are dissatisfied with Warranty repairs. You should also contact the Lode King Warranty Department at this toll free number or mailing address in the event it is necessary to have Warranty repairs performed at a site other than an authorized Lode King service center or dealer. Any repairs performed at a site other than an authorized Lode King service center or dealer must be authorized in advance and in writing by the Lode King Warranty Department before Warranty work can be done. Prior authorization is necessary to ensure the availability of Warranty coverage and to determine that the facility is qualified to perform such repair work.
8. **Time Limitation for Initiating Claims.** To the maximum extent permitted by applicable law, any claim for breach of this Warranty or any applicable implied or statutory warranty must be initiated within 30 days after the date on which the breach allegedly occurs, and in no event later than the expiration dates of specific Warranties set forth in paragraph 1, above.
9. **Sole and Exclusive Remedy.** To the maximum extent permitted by applicable law, your sole and exclusive remedy for breach of this Warranty is monetary damages in an amount equal to the actual cost of material and/or labor necessary to repair or replace defective parts that were not repaired or replaced in accordance with this Warranty. Special, incidental and consequential damages are not recoverable. Some states or provinces may not allow for the exclusion or limitation of special, incidental or consequential damages, and in such states and provinces, the above limitation or exclusion may be limited or may not apply at all.

10. **Improvements and Changes.** Product improvement is an ongoing process at Lode King. We reserve the right to change specifications, operating instructions, standards and options on any and all products without prior notice and without imposing any additional obligation on Lode King to install the same upon its products which were manufactured prior to such changes.

THIS WARRANTY GIVES YOU SPECIFIC LEGAL RIGHTS, AND YOU MAY ALSO HAVE OTHER RIGHTS WHICH VARY FROM STATE TO STATE AND/OR BY PROVINCE.

TABLE OF CONTENTS

Please read this manual carefully and completely before operating or performing maintenance on your trailer. If you have any questions regarding your trailer, please contact your nearest authorized dealer.

SECTION 1 – INTRODUCTION	1
SECTION 2 – SAFETY	2
2.1 – Operating Safety	3
2.2 – Maintenance Safety	4
2.3 – Travel Safety	4
2.4 – Loading Safety	4
2.5 – Safety Signs.....	4
2.6 – Sign-Off Form	5
2.7 – Reporting a Safety Defect.....	6
SECTION 3 – SAFETY SIGN LOCATIONS	7
SECTION 4 – OPERATION GUIDELINES	15
4.1 – To the New Operator or Owner	15
4.2 – Principle Components	16
4.3 – Break-In.....	18
4.4 – Pre-Operation Vehicle Inspection Procedure	19
4.5 – Coupling & Uncoupling Procedures	21
4.5.1 – Coupling Procedure – Tractor to Trailer or Lead to Pull	21
4.5.2 – Uncoupling Procedure.....	23
4.5.3 – Uncoupling the Pull.....	24
4.6 – Loading/Unloading the Trailer	24
4.6.1 – Load Rating	24
4.6.2 – Loading/Unloading	25
4.6.3 – Load Location and Securement	25
4.6.4 – Load Securement	26
4.7 – Transporting	27
4.7.1 – Operating Instructions	27
4.7.2 – Braking Guidelines.....	27
4.7.3 – Tires	28
4.7.4 – Tire Inflation System.....	29
4.7.5 – Run-empty Axle Lifts	30
4.8 – Flip-Over Beavertail Ramps	31

TABLE OF CONTENTS CONTINUED

SECTION 5 – SERVICE AND MAINTENANCE33

- 5.1 – Alterations to the Trailer 34
- 5.2 – Trip Servicing 35
- 5.3 – Kingpin and Upper Coupler 36
- 5.4 – Suspension and Axles 36
 - 5.4.1 – Pivot Connection 36
 - 5.4.2 – Ride Height Setting 36
 - 5.4.3 – Axle Alignment 39
 - 5.4.4 – Fasteners 40
 - 5.4.5 – Air Bags 41
 - 5.4.6 – Shock Absorbers 41
 - 5.4.7 – Control Valve 41
- 5.5 – Wheel Ends 42
 - 5.4.8 – Seals 42
 - 5.5.1 – Wheel Bearing Clearance/End Play 44
 - 5.5.2 – Hub Cap 45
- 5.6 – Brakes 46
 - 5.6.1 – Brake Drums 46
 - 5.6.2 – Brake Shoes and Friction Lining 46
 - 5.6.3 – S-cam 46
 - 5.6.4 – Slack Adjusters & Brake Chambers 47
 - 5.6.5 – Anti-Lock Brake System 48
- 5.7 – Wheels and Tires 50
 - 5.7.1 – Wheel Nut Retorque Procedure 50
 - 5.7.2 – Tires 52
 - 5.7.3 – Tire Changing Procedure 53
 - 5.7.4 – Wheels 54
- 5.8 – Air System Components and Schematics 55
- 5.9 – Electrical System 60
- 5.10 – Fifth Wheel on Lead 62
- 5.11 – Paint Finish 63

SECTION 6 – PREVENTATIVE MAINTENANCE SUMMARY 64

SECTION 7 – TROUBLE SHOOTING66

SECTION 8 – INDEX70

INTRODUCTION

The trailer you have just taken delivery of has been carefully designed and built for easy operation, simple maintenance and reliability, to meet the demands of a discerning transporting industry.

We take this opportunity to thank you for choosing Lode King, and assure you of Lode King's interest in the continued safe and reliable operation of this equipment through its dealer and service network in the field.

Safe, efficient and trouble free operation of your trailer requires that you and anyone else who will be operating or maintaining the trailer, read this manual carefully and understand the Safety, Operation, Maintenance and Trouble Shooting information contained within this Owner's Manual.

This manual has been prepared to provide recommendations and guidelines for the safe operation of the tandem and triple axle, single or B-Train Flat and Step Deck Trailers. It is important to follow these recommendations and to use prudent caution during the operation of this trailer. Doing so in addition to performing important maintenance procedures will help ensure dependable vehicle performance in a safe manner. All persons who operate this trailer should familiarize themselves with these recommendations.

The manual includes safety checks that the operator should perform periodically. Careful and complete inspections and verifications of the condition of the parts, components and mechanics of a trailer should be performed in accordance with this manual, as well as in accordance with the instructions of suppliers to Lode King Industries of the particular part or component. It is strongly recommended that the end user follow these specific maintenance instructions. This inspection is essential each time a trailer is to be operated.

It is important that every trailer owner and/or operator have an organized Trailer Preventive Maintenance program (TPM). Government regulations in both Canada and the United States requires that maintenance records be retained as evidence of completion of the maintenance checks on every commercial highway vehicle. In addition, it is to the end user advantage to be able to show that regularly scheduled TPM inspection checks have been performed on every piece of equipment operated.

This manual is not intended to be a comprehensive service manual. When repairs become necessary it is strongly recommended that a qualified mechanic be used to perform the repairs. Your authorized dealer has the qualified staff and facilities available to address all of your maintenance needs.

The trailer owner and operator need to be familiar with two organizations that support the commercial transport industry. The Commercial Vehicle Safety Alliance (CVSA) is a not-for-profit organization that promotes vehicle safety. The CVSA publishes information regarding safe usage of commercial vehicles. Visit their website at cvsa.org for all the details on this valuable organization.

The other organization is the Technology and Maintenance Council (TMC) branch of the American Trucking Association. The TMC provides valuable knowledge and expertise on thorough and competent maintenance of your trailer. Specifically, the TMC publishes an extensive series of Recommended Practices (RP) to assist in repairs. Visit their website at tmconnect.trucking.org to learn about the TMC.

Throughout this manual you will find references to both the CVSA and the TMC.

Please read the presented manual carefully and keep with the trailer at all times. Should one have any questions, contact your dealer representative.

OPERATOR ORIENTATION

The directions "roadside" and "curbside" as mentioned throughout this manual, are taken as if the operator was sitting in the driver seat of the tractor facing forward and "roadside" being on the left and "curbside" being to the right.

KEEP THIS MANUAL HANDY FOR FREQUENT REFERENCE AND TO PASS ON TO NEW OPERATORS OR OWNERS.

SAFETY

SAFETY ALERT SYMBOL

This Safety Alert symbol means
ATTENTION! BECOME ALERT!
YOUR SAFETY IS INVOLVED!



The Safety Alert symbol identifies important safety messages on the trailer and in the manual. When you see this symbol, be alert to the possibility of personal injury or death. Follow the instructions in the safety message.

THREE BIG REASONS WHY SAFETY IS IMPORTANT TO YOU

1. Accidents Disable and Kill
2. Accidents Cost
3. Accidents Can Be Avoided

NOTE

Note the use of the signal words DANGER, WARNING and CAUTION with the safety messages. The appropriate signal word for each message has been selected using the following guide-lines:

WARNING

ORANGE LABEL

A specific hazard or unsafe practice which **COULD** result in severe personal injury or death if proper precautions are not taken.

DANGER

RED LABEL

An immediate and specific hazard which **WILL** result in severe personal injury or death if the proper precautions are not taken.

CAUTION

YELLOW LABEL

Unsafe practices which **COULD** result in personal injury if proper practices are not taken, or as a reminder of good safety practice.

SAFETY

The operator is responsible for the SAFE operation and maintenance of your trailer. The operator must ensure that you and anyone else who is going to operate, maintain or work around the trailer be familiar with the operating and maintenance procedures and related SAFETY information contained in this manual.

Remember, the operator is the key to safety. Good safety practices not only protect you but also the people around you. Make these practices a working part of your safety program. Be certain that EVERYONE operating this equipment is familiar with the recommended procedures and follows all the safety precautions. Remember, most accidents can be prevented. Do not risk injury or death.

- Trailer owners must give operating instructions to operators or employees before allowing them to operate the equipment, and at least annually thereafter.
- The most important safety device on this equipment is a SAFE operator. It is the operator's responsibility to read and understand ALL Safety and Operating instructions in the manual and to follow these. Accidents can be avoided.
- Lode King recommends that a person read and understand this Owner's Manual as part of a comprehensive safety program, as part of becoming a qualified operator of the trailer.
- Do not modify the equipment in any way. Unauthorized modification may impair the function and/or safety of the equipment and affect trailer warranty.

**THINK SAFETY!
WORK SAFELY!**

2.1 - OPERATING SAFETY

1. Read and understand the Owner's Manual and all safety signs before operating, maintaining or adjusting the trailer.
2. Do not allow riders on any part of the trailer during field, road or highway operations.
3. Drive very carefully when negotiating hilly or uneven terrain.
4. Place all controls in neutral, stop the engine, set park brake, remove ignition key before servicing, adjusting, repairing or maintaining.
5. Exercise extreme caution when working around or near moving parts of the trailer keeping hands, feet, clothing, and hair away from all moving parts of equipment operated in conjunction with your trailer.
6. Clear the area of all bystanders, especially children, before starting up and operating the tractor and trailer.
7. Make sure that all lights and conspicuity tape required by all regulatory agencies or authorities are in place, clean, and can be seen clearly by all traffic.
8. Review the owner's manual and all related operating, maintenance and safety information annually with all personnel who will be working with or around the trailer.
9. Before disconnecting the tractor from the trailer
 - a. Make sure that the tractor and trailer are on level ground and that the trailer parking brake is applied.
 - b. Ensure the air is dumped out of the trailer suspension before disconnecting.
 - c. Make sure that the landing gear of the trailer being disconnected is down. If the ground area below the landing gear is soft or of a questionable type ensure that additional pad area is provided so that the landing gear will not sink.

2.2 - MAINTENANCE SAFETY

1. Read and understand all the information in the Owner's Manual regarding maintaining, adjusting and operating the trailer unit.
2. Stop the engine, remove ignition key and set the park brake before adjusting, servicing or maintaining any part of the trailer unit.
3. Review the Owner's Manual and all related maintenance, operating and safety information annually with the personnel who will be working with, maintaining or operating the trailer.

2.3 - TRAVEL SAFETY

1. Read and understand all the information in the Owner's Manual regarding procedures and safety when operating the trailer unit in the field or on the road.
2. Make sure all the lights and conspicuity tape required by all regulatory agencies or authorities that are required by the local highway and transport authorities are in place, are clean and can be seen clearly by all traffic.
3. Drive carefully and defensively at all times and especially when negotiating uneven or hilly terrain.
4. Do not allow riders on any part of the trailer during field, road, or highway operations.
5. Make sure you are in compliance with all local regulations regarding transporting on public roads and highways. Consult your local law enforcement agency for further details.
6. Do not drink and drive. Do not allow others to drink and drive.
7. Do not text or use a cell phone while driving. Do not allow others to text or use a cell phone while driving.
8. Only use 'hands free' system when making calls when behind the wheel.
9. Do not drive when under the influence of drugs. Do not allow others to drive while under the influence of drugs.

2.4 - LOADING SAFETY

1. To prevent damaging the trailer do not drop load onto the trailer.
2. Ensure the air is exhausted (dumped) from the air suspension during loading and unloading.

2.5 - SAFETY SIGNS

1. Keep safety signs clean and legible at all times.
2. Replace safety signs that are missing or have become illegible.
3. Replaced parts that displayed a safety sign should also display the current sign.
4. Any safety signs that become damaged or otherwise illegible should be replaced. New safety decals are available through your dealer.
5. Install signs in accordance with recommended instructions which will accompany replacement signs.

**THINK SAFETY!
WORK SAFELY!**

2.7 - REPORTING A SAFETY DEFECT

Your trailer was designed and built to conform to industry standards, as well as comply with all Transport Canada safety standards. It has been constructed with great attention to detail following a rigorous quality control system. However, in spite of best intentions it is possible that a defect may exist in the trailer. If, at any time, you believe your trailer has a defect in it which could cause an accident or could cause an injury or death, you must immediately advise:

Lode King Industries
135 Canada St
Box 1146
Winkler, Manitoba, Canada R6W 4B2
Phone: 1-204-325-4345
Fax: 1-204-325-5369

Once the circumstances and details are known, corrective action will be taken to address the issue.

If the scope of the defect should have wider implications for other trailers in this product line Lode King will take action to initiate a formal Transport Canada Recall Campaign.

If you believe your trailer possesses such a defect that could cause an accident or create a risk to safe operation, you may also report the defect to Transport Canada. Go to the Transport Canada website at tc.gc.ca for contact information and details on how to report a safety related defect.

**THINK SAFETY!
WORK SAFELY!**

SAFETY SIGN LOCATIONS

The types of signs and locations on the equipment are shown in the illustrations below. Good safety requires that you familiarize yourself with the various Safety Signs, the type of warning and the area, or particular function related to that area, that requires your SAFETY AWARENESS.

A

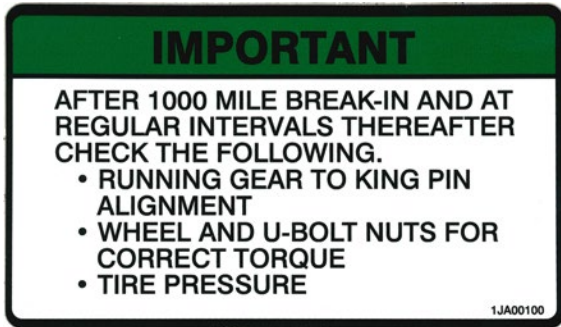



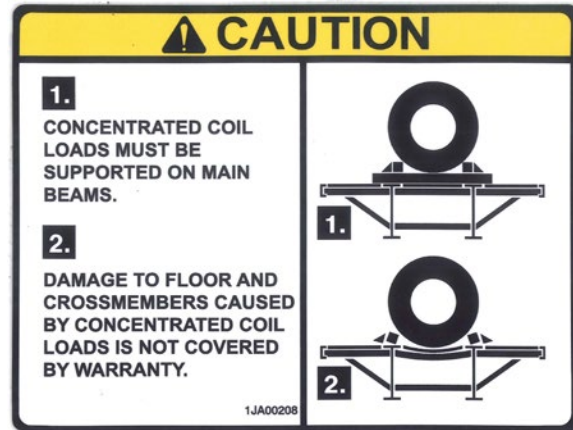

B

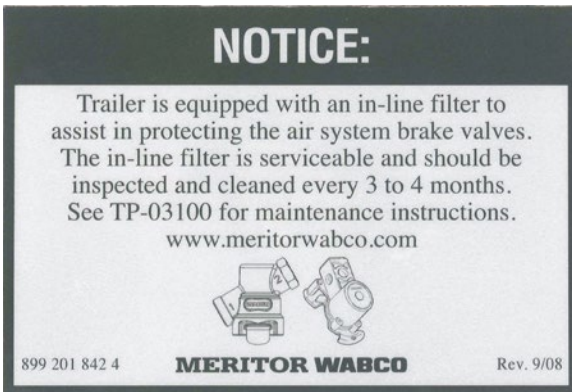

C

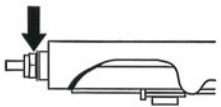

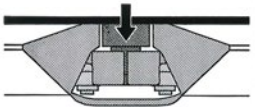
D

⚠ WARNING / ADVERTENCIA / AVERTISSEMENT		
<p>ALWAYS inspect fifth wheel after coupling tractor to trailer. Failure to properly couple the tractor and trailer could result in tractor-trailer separation while in use which, if not avoided, could result in death or serious injury.</p>	<p>SIEMPRE inspeccione la quinta rueda después de acoplar el tractocamión al remolque. Si no acopla adecuadamente el tractocamión y el remolque, podría ocasionar la separación del tractocamión y el remolque durante el uso, lo cual, si no se evita, podría causar muertes o lesiones graves.</p>	<p>TOUJOURS contrôler la sellette d'attelage après avoir accouplé le tracteur à la remorque. Un mauvais accouplement de la remorque sur le tracteur peut résulter en une séparation du tracteur et de la remorque susceptible de provoquer la mort ou des blessures graves.</p>
CORRECT COUPLING / ACOPLAMIENTO CORRECTO / ACCOUPLEMENT CORRECT		
<p>1. Nut and washer snug against fifth wheel. Tuerca y arandela ajustadas contra la quinta rueda. Écrou et rondelle serrés contre la sellette.</p> 	<p>2. No gap Sin separación Pas d'espace</p> 	<p>3. Locks completely closed around kingpin. Seguros completamente cerrados alrededor del perno rey. Mâchoires complètement fermées sur le pivot.</p> 
	Copyright © 2012 • SAF-HOLLAND, Inc.	www.safholland.us
		XL-FW350 Rev. N



REMEMBER
If Safety Signs have been damaged, removed, become illegible or parts replaced without signs, new signs must be applied. New signs are available from your authorized dealer.

**THINK SAFETY!
WORK SAFELY!**

E



F

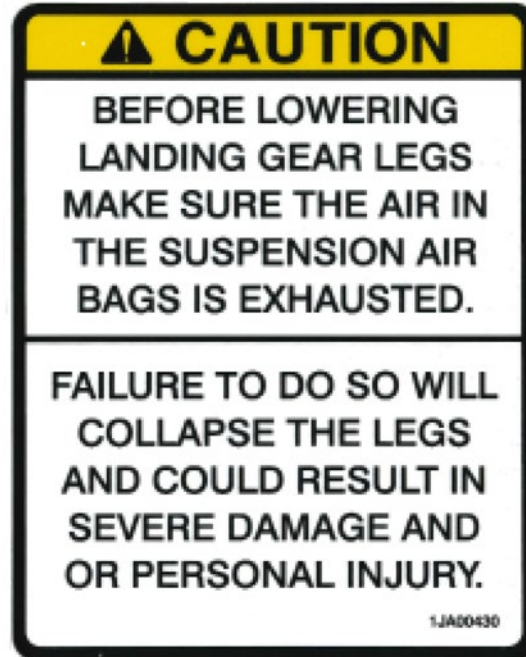

G



REMEMBER
If Safety Signs have been damaged, removed, become illegible or parts replaced without signs, new signs must be applied. New signs are available from your authorized dealer.



H

WARNING

Nut Tightening Sequence
8 and 10 Hole Systems

Failure to follow these instructions may result in wheel loss, which can lead to property damage, injury or death. Refer to the product service of owner's manual for additional information.

This vehicle is equipped with hub-piloted disc wheels, flange nuts, and **M22 x 1.5** studs. Tighten to 50 ft-lbs torque in the sequence shown and then torque to **450-500 ft-lbs oiled*** using the same tightening sequence. Retorque between 50-100 miles after installation and at each regularly scheduled service interval.

*Oiled- Apply two drops of oil to a point between the nut and flange and two drops to the two or three threads at the end of each stud.

Walther EMC 3501 Shotwell Drive Franklin, Ohio Phone: 937-743-8125

**THINK SAFETY!
 WORK SAFELY!**

J

CAUTION:

Brake lining contains non-asbestos fibers. Wear approved eye protection and respirator when working on or near the brakes to prevent a possible health hazard.

HENDRICKSON
 Trailer Suspension Systems

L568 February 1997 Printed in United States of America

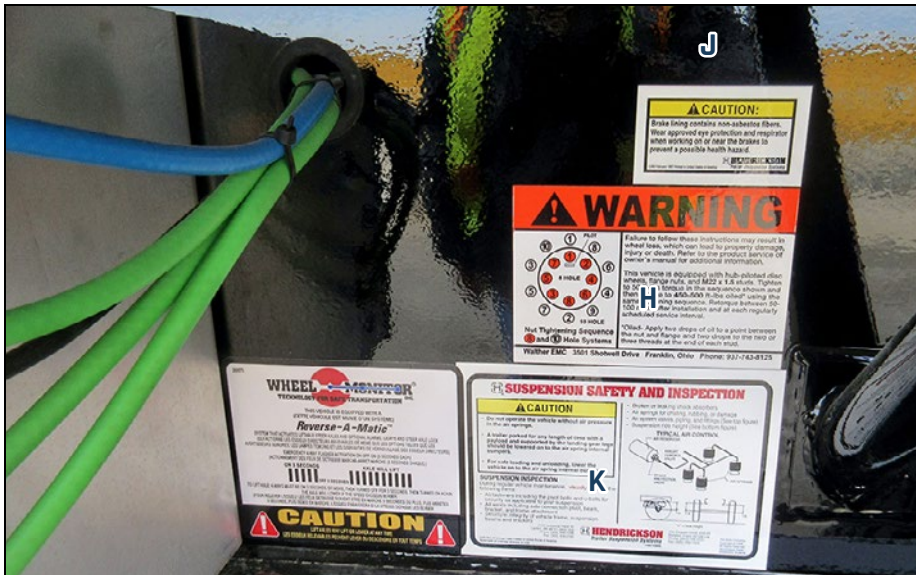

K

H SUSPENSION SAFETY AND INSPECTION

CAUTION

- Do not operate the vehicle without air pressure in the air springs.
- A trailer parked for any length of time with a payload and supported by the landing gear legs should be lowered on to the air spring internal bumpers.
- For safe loading and unloading, lower the vehicle on to the air spring internal bumpers.

SUSPENSION INSPECTION
 During regular vehicle maintenance, **visually** inspect the following items:

- All fasteners including the pivot bolts and u-bolts for security as applicable to your suspension
- All welds including axle connection pivot, beam, bracket, and frame attachment
- Structure: integrity of vehicle frame, suspension beams and brackets

2070 Industrial Place SE
Canton, OH 44707-2600 USA
Phone: (330) 456-7288
Fax: (330) 456-0105

HENDRICKSON
Trailer Suspension Systems
A Boler Company

250 Chrysler Drive, Unit #3
Brampton, Ontario L6S 6S6 CAN
Phone: (905) 789-1030
Fax: (905) 789-1033

The Boler Company,
Copyright © 1998
All Rights Reserved
Hendrickson Trailer
Suspension Systems

L121 Rev. B October 1998 Printed in United States of America
Supersedes all previous versions of L121

- Broken or leaking shock absorbers
- Air springs for chafing, rubbing, or damage
- Air system valves, piping, and fittings (See top figure)
- Suspension ride height (See bottom figure)

TYPICAL AIR CONTROL

A = Ride Height

L

WARNING

Do not drill or weld main beams!
 Welding or drilling main beams will void any warranty and may result in catastrophic beam failure causing a serious accident, leading to injury or death.

1JA00320B

THINK SAFETY! WORK SAFELY!

The types of signs and locations on the equipment are shown in the illustration below. Good safety requires that you familiarize yourself with the various Safety Signs, the type of warning and the area, or particular function related to that area, that requires your SAFETY AWARENESS.

M



N



The types of signs and locations on the equipment are shown in the illustration below. Good safety requires that you familiarize yourself with the various Safety Signs, the type of warning and the area, or particular function related to that area, that requires your SAFETY AWARENESS.

O

NOTICE:

If the ABS indicator lamp comes on *and* stays on when you apply the brakes to a *moving* vehicle, the trailer ABS is not working properly. The ABS must be serviced as soon as possible upon completion of your trip to ensure full anti-lock braking capability.

TP-95172 **MERITOR WABCO** Rev. 7/01



P

INTRAAAX® SUSPENSION SAFETY

CAUTION

IMPROPER AIR SPRING PRESSURE CAN CAUSE DAMAGE TO THE VEHICLE OR SUSPENSION OR SEVERE PERSONAL INJURY. **DO NOT OPERATE THE VEHICLE WITHOUT AIR PRESSURE IN AIR SPRINGS.** Lower trailer onto internal air spring bumpers if it is supported by the landing gear legs and parked with a payload for any length of time. Lower the trailer onto internal air spring bumpers for safe loading and unloading.

INTRAAAX SUSPENSION INSPECTIONS

Inspect the following items during regular vehicle maintenance:

- Vehicle frame, suspension beams, brackets and other structural components for cracks or other damage
- All fasteners for proper torque or damage
- All welds for cracks or other damage
- Air springs for chafing, rubbing or damage
- Shock absorbers for leaks or damage
- Suspension ride height

INTRAAAX TORQUE SPECIFICATIONS

QUIK-ALIGN® Pivot Bolt: 550±45 ft. lbs. (750±50 N•m) **Shock Bolt (Upper and Lower): 225±10 ft. lbs. (300±10 N•m)**

Do not reuse bolts. For more torque specifications, refer to Hendrickson publication B31. For pivot connection fastener information, refer to Hendrickson publication B92. All Hendrickson publications can be found online at www.hendrickson-intl.com.

CAUTION

DO NOT APPLY anti-seize compound or additional lubricant to pivot connection hardware. This can lead to overtightened fasteners, unpredictable pivot connection clamp loads and unreliable axle alignments. Reference L579.

Trailer Commercial Vehicle Systems
 2070 Industrial Place SE
 Canton, OH 44707-2941 USA
 866.RIDE.AIR (743.5247)
 330.469.0245
 FAX 330.696.4416

HENDRICKSON
www.hendrickson-intl.com

Hendrickson Canada
 250 Chrysler Drive, Unit #3
 Inverness, ON Canada L6G 6B6
 905.789.1030
 FAX 905.789.1033

L975 Rev C 01-15 ECN 23768 ©2015 Hendrickson USA, L.L.C. All Rights Reserved Printed in United States of America

Q

CAUTION

LOAD RATINGS: B-TRAIN PLATFORM - NORMAL DUTY

MAXIMUM CONCENTRATED LOADS:

TRAILER TYPE	4 FEET		10 FEET		20 FEET		UNIFORMLY DISTRIBUTED LOAD	
	LB	KG	LB	KG	LB	KG	LB	KG
LEAD	35,000	15,500	42,500	19,000	50,000	22,500	60,000	27,000
PULL	35,000	15,500	42,500	19,000	50,000	22,500	60,000	27,000

ALL LOAD RATINGS ARE BASED ON:
 1. LOAD LOCATED IN THE CENTER OF DECK
 2. LOAD RATINGS FOR BEAMS ONLY. FLOORING, CROSS MEMBERS & SPACING, SUSPENSIONS, AXLES, BRAKES, TIRES, ETC, MUST BE RATED FOR EACH TRAILERS APPLICATION
 3. OPERATING CAPACITY OF TRAILER MUST COMPLY WITH LEGAL REQUIREMENTS AND GVWR.

PRESTIGE WINKLER, MANITOBA 1JA00801

R

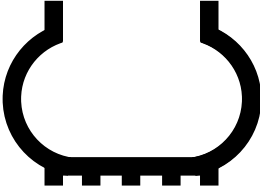
⚠ WARNING		
	<p>IMPROPER WHEELS OR VALVE STEMS can interfere with air disc brakes and cause rapid tire deflation, component damage, loss of vehicle control, property damage, or severe personal injury.</p>	
	<p>Use wheels and valve stems that provide proper running clearance with air disc brakes equipped on this suspension.</p>	
	<p>Contact vehicle manufacturer to determine replacement wheels and valve stems approved for this application.</p>	
<p>Trailer Commercial Vehicle Systems 2070 Industrial Place SE Canton, OH 44707-2641 USA 866. (RIDEAIR) 743.3247 330.489.0045 Fax 800.696.4416</p>	<p>HENDRICKSON www.hendrickson-intl.com</p>	<p>Hendrickson Canada 250 Chrysler Drive, Unit #3 Brampton, ON L6S 6B6 Canada 800.668.5360 905.789.1030 Fax 905.789.1033</p>
<p>L879 09-04 Printed in the United States of America. Copyright © 2004. All Rights Reserved.</p>		



THINK SAFETY! WORK SAFELY!

The types of signs and locations on the equipment are shown in the illustration below. Good safety requires that you familiarize yourself with the various Safety Signs, the type of warning and the area, or particular function related to that area, that requires your SAFETY AWARENESS.

OPERATION GUIDELINES

MAINTENANCE SAFETY

1. Read and understand the Owner's Manual and all safety signs before operating, maintaining or adjusting the trailer.
2. Do not allow riders on any part of the trailer during field, road or highway operations.
3. Drive very carefully when negotiating hilly or uneven terrain.
4. Place all controls in neutral, stop the engine, set park brake, remove ignition key before servicing, adjusting, repairing or maintaining.
5. Exercise extreme caution when working around or near moving parts of the trailer keeping hands, feet, clothing, and hair away from all moving parts of equipment operated in conjunction with your trailer.
6. Clear the area of all bystanders, especially children, before starting up and operating the tractor and trailer.
7. Make sure that all lights and conspicuity tape required by all regulatory agencies or authorities are in place, clean and can be seen clearly by all traffic.
8. Review the operators manual and all related operating, maintenance and safety information annually with all personnel who will be working with or around the trailer.
9. Before disconnecting the tractor from the trailer
 - a. Make sure that the tractor and trailer(s) are on level ground and that the trailer parking brake is applied.
 - b. Ensure the air is dumped out of the trailer suspension before disconnecting.
 - c. Make sure that the landing gear of the trailer being disconnected is down. If the ground area below the landing gear is soft or of a questionable type ensure that additional pad area is provided so that the landing gear will not sink.

4.1 - TO THE NEW OPERATOR OR OWNER

Be sure to familiarize yourself with the trailer by reading this Owner's Manual and the Safety Alerts before attempting to operate it. Be familiar with its principles of operation. With careful use and a good maintenance schedule the unit will give many years of trouble-free use.

It is the responsibility of the owner and operator to be familiar with the weights and loading of the trailer or combinations of trailers. Vehicle weight and loading restrictions vary from jurisdiction to jurisdiction. Be familiar with any restrictions of the jurisdiction in which you will be operating the unit(s).

In addition to the design and configuration of equipment, hazard control and accident prevention are dependant upon the awareness, concern, prudence and proper training of personnel involved in the operation, transport, maintenance, and storage of this equipment.

It is the responsibility of the owner or operator to read this manual and to train all other operators before they start working with the machine. Follow all safety instructions exactly. Safety is everyone's business. By following recommended procedures, a safe working environment is provided for the operator, bystanders, and the area around the trailer and work site. Untrained operators are not qualified to operate the machine.

4.2 - PRINCIPLE COMPONENTS

Flat and Step Deck Trailers are large flat and stepped platforms for transporting large objects from one location to another. They are designed for on-highway applications.

Each trailer is equipped with components to connect a variety of load securement tie downs. These include but are not limited to winches, chains, stake pockets, and hooks. Cargo or loads can be mounted on the upper or lower deck.

- A B-Train, Lead
- B B-Train, Pull
- C Flat Deck Trailer
- D Step Deck Trailer
- E Four Axle Trailer
- F Landing Gear
- G Rear Bumper
- H Lift-Axle Steer Control (if so equipped)
- J Wide Load Clearance Lights
- K Storage / Tool Box Compartment
- L B-Train, Fifth Wheel
- M Suspension Control Box
- N Deck – Steel Flanges
- O Deck – Aluminum Flooring
- P Winch
- Q Chain Anchor
- R Stake Pocket
- S J-Hook Anchor



Figure 1



Figure 2

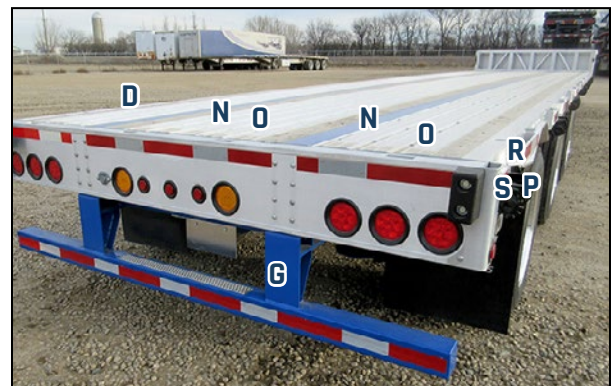

Figure 3

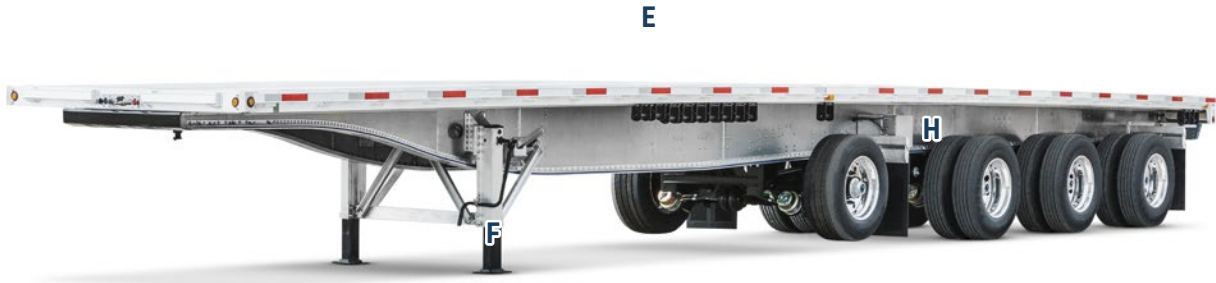

Figure 4

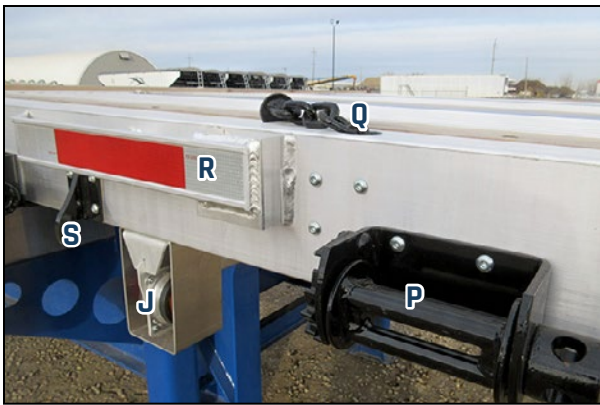

Figure 5



Figure 6



Figure 7

4.3 - BREAK-IN

The normal break-in procedure for a trailer is simple and straight forward, as follows:

DAILY PRE-TRIP INSPECTION

NOTE

The pre-trip inspections are also included in a later section of this owners manual. They are included in the Break-In section as they are an important aspect of putting a new trailer into service. If any defects or issues are present from the manufacturing process they will usually become apparent as soon as the trailer is put into service.

1. Check tire inflation pressure.
2. Check for any loose wheel nuts. If any are found, retorque them. Refer to section 5.7 for detailed steps on how to retorque the wheel nuts.
3. Check adequate oil in the wheel hubs.

WARNING

Excessive heat build up in a wheel hub usually points to a more significant problem. Either a seal failure has allowed the lubricant to leak out or a catastrophic bearing failure is imminent. It is critically important that the source of this problem be immediately identified and corrected. An in-service bearing failure can lead to a dangerous situation such as a wheel-off or a fire.

4. Check that the slack adjusters remain within the correct operating range. Refer to Section 5.6.
5. Check that all lights are functioning properly on the trailer.

1,000 MILE / 1,600 KM INSPECTION:

After the first 1,000 miles/1,600 km of service some “settling in” will have occurred, particularly in the suspension components.

At this time:

1. Inspect all fasteners in the suspension to ensure nothing has come loose.
2. Retorque all wheel nuts. Refer to Section 5.7.1 in the Maintenance section of this manual for correct procedure on retorquing.

3. Check oil levels in hubs where applicable. Top up as required. If low, check for leaks and repair. Do not operate the trailer with inadequate lubricant in the hubs.
4. Jack up the axles. Spin the wheels to check for excessive play in the bearings and smooth rotation. If any looseness or roughness is detected, determine the cause and fix it.
5. While turning the wheels check for dragging brakes (or wheels will not turn by hand). If brakes are dragging, determine the cause and fix immediately.
6. Perform a visual inspection of all framework for any signs of deformation or cracks. If any such damage is found remove the unit from service until the damage is corrected.
7. Check all lights to ensure none are damaged and are functioning properly.

10,000 MILES/16,000 KMS INSPECTION:

After the first 10,000 miles/16,000 km of service perform the same checks as after 1,600 kms.

1. Ensure the lubrication is performed as outlined in Section 5 of this manual.

25,000 MILES/ 40,000 KMS INSPECTION:

Upon completion of 25,000 miles/40,000 kms perform the 1,600 kms inspections once again.

In addition:

1. Remove the wheels and brake drums from each axle and inspect the brake linings for excessive or irregular wear. If any problems are uncovered, repair immediately.
2. While the brake drums are off, check the wheel bearings for smooth operation or excessive free play. Correct any problems that are discovered.
3. Check the axle alignment. Refer to the Maintenance Section of this manual.
4. Ensure the lubrication is performed as outlined in Section 5 of this manual.

From this point the owner can move to the normal service schedule as outlined in the Service Section of this manual.

4.4 - PRE-OPERATION VEHICLE INSPECTION PROCEDURE

The safe and trouble-free use of a trailer requires the operator to maintain the unit in good operating condition. This begins by performing a walk around visual inspection each day before putting the trailer into service.

NOTE

The pre-trip inspection of the driver, tractor, and trailer is a key element in safe and efficient operation of any tractor/semi-trailer combination. This manual will only look at the trailer aspects of the pre-trip inspection. The owner of the trailer is strongly urged to implement a thorough safety inspection program based on this information as well as available industry standards. For example, the Commercial Vehicle Safety Alliance (CVSA) publishes inspection standards that apply all over North America. Their website is cvsa.org. In addition, most provincial and state governments have information available on-line which lays out specific details on the pre-trip inspection. This manual should serve to supplement such publically available information. To assist the operator the following pre-operation checklist is provided.

1. Prior to connecting the tractor or Pull trailer
 - a. Inspect the king pin and upper coupler area for any damage or distortion.
 - b. Ensure adequate grease is applied to the tractor or Lead fifth wheel.
2. After connecting the tractor
 - a. Ensure the fifth wheel is fully engaged and locked onto the trailer king pin.
 - b. Ensure both air line glad hands are free of dirt, debris, and damage, then positively connect the tractor or Lead trailer air lines.
 - c. Check the electrical nose plug for any damage. If none is found, positively connect the electrical cord from the tractor. Ensure the safety catch on the lid of the plug is engaged to prevent accidental disconnection.
 - d. Ensure the air and electrical lines are properly secured against tangling, snagging and chafing, with sufficient slack to allow for turning.
3. With air and electrical power connected
 - a. Allow sufficient time for the trailer air tanks to fill from the tractor. Listen for any indication of air leaking, making a hissing noise. **DO NOT** operate the trailer if a leak is detected; have it repaired first.

Figure 8 helps to illustrate the sequence of this work.

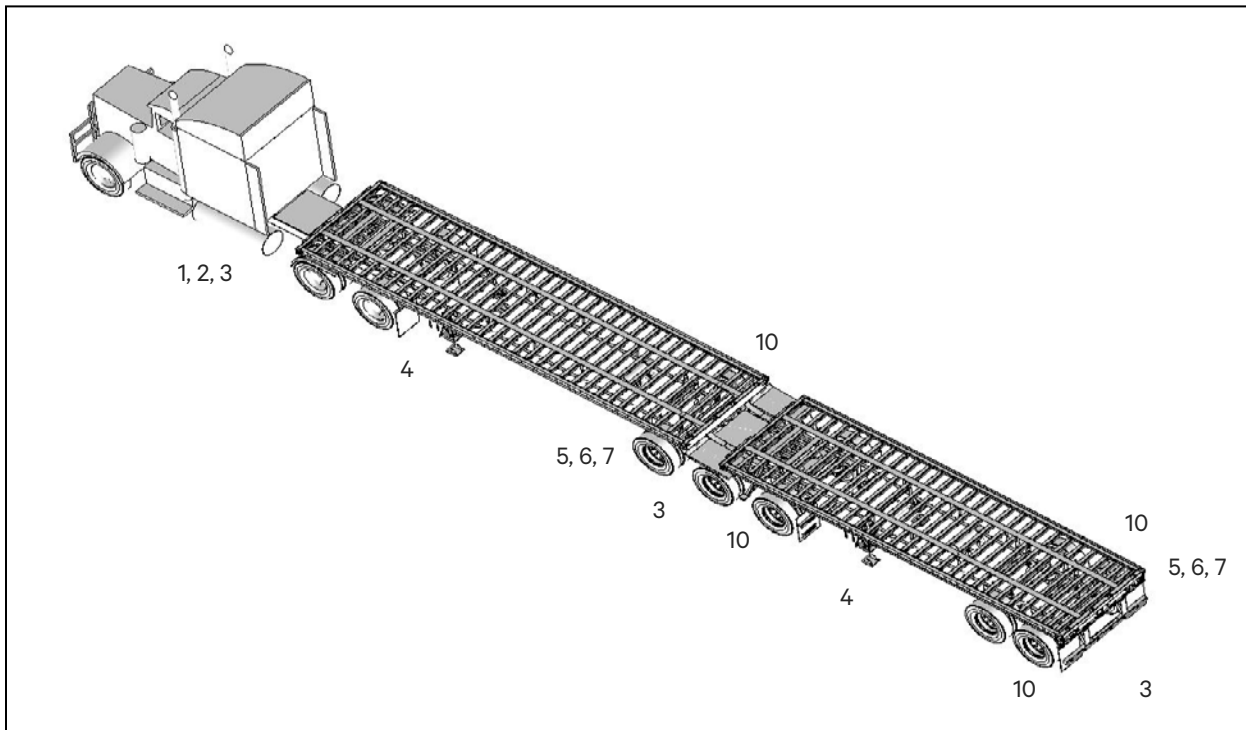

Figure 8 – Walk Around Inspection

NOTE

With the trailer air tanks fully charged and the tractor engine OFF, air loss on the trailer should not exceed 3 psi per minute. If leakage is in excess of this level, find out what is leaking and have it repaired before using the trailer.

- b. Check all lights on the trailer for proper function. Repair any that are not working.
 - c. Check to ensure all conspicuity tape is still in place and visible. Clean or repair if necessary.
4. Ensure landing gear legs are cranked “up” and securely retracted. Stow the landing gear crank in the bracket provided.

WARNING**CRUSH HAZARD**

It is necessary to go under the trailer to perform the following inspections. Ensure the parking brakes are engaged and/or the wheels are properly blocked to prevent the trailer from rolling or moving while you are under the trailer.

5. Drain moisture from air tanks by opening the petcock on each tank and venting a small amount of air. Once no more moisture is seen in the stream of air, close the petcock securely. See Figure 9 below.
6. Visually inspect air brake hoses, brake chambers and slack adjusters for damage. If any is found, have it repaired before putting the trailer into service.

7. Check the travel of the slack adjusters. Dimensions for correct travel are provided in the Service section of this manual.
8. Once all of the visual inspections are successfully completed, the function of the brake system must be tested. With the tractor securely connected to the trailer, and Pull king pin and any blocks or wheel chocks removed, start the engine of the tractor. With the trailer emergency brakes still engaged, attempt to pull forward slightly. This should confirm that the king pin is properly locked into the jaws of the tractor and Pull fifth wheel. At the same time confirm that the emergency brakes are holding. If any problems are found at this point have them corrected before using the trailer.
9. Release the emergency brakes. Proceed to drive forward at low speed then apply the service brakes of the trailer independently from the tractor. Ensure the trailer service brakes are functioning properly.

CAUTION

Perform these brake function tests only in a safe area away from other traffic.

10. Check the tires to ensure they are all holding air and are inflated to the correct pressure. Remove foreign objects caught in the tread or between dual tires.
11. Once everything checks out, you are ready to go to work.

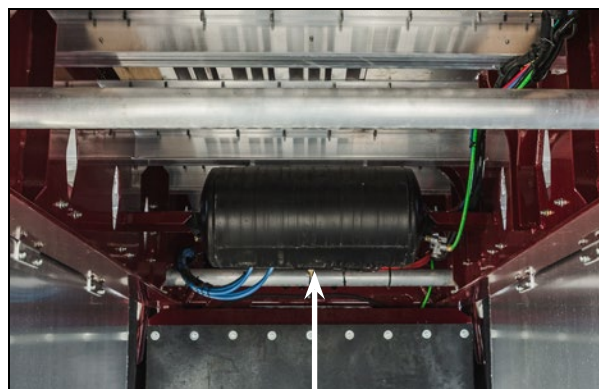

Figure 9 – Petcock (Typical)

4.5 - COUPLING & UNCOUPLING PROCEDURES

4.5.1 - COUPLING PROCEDURE - TRACTOR TO TRAILER OR LEAD TO PULL

Connecting a highway tractor to your Lead or Pull trailer is the same as for any semi-trailer. Proceed as follows:

1. Ensure that the lock on the tractor or Lead fifth wheel is released and the jaws are "OPEN" and ready to couple with the trailer. Apply grease to the tractor or Lead fifth wheel if needed.
2. Slowly back the tractor or Lead up to the trailer, approximately aligned with the trailer. Once near the trailer, STOP, and verify that the king pin in centred on the rear opening of the fifth wheel. Verify that the pick-up throat on the trailer is sufficiently high so that the tractor or Lead will get underneath it.
3. Continue to back up slowly ensuring the trailer king pin remains centred in the rear opening throat of the fifth wheel.
4. As you back under the upper coupler of the trailer it should slide up the fifth wheel, taking the weight off the trailer landing gear. Keep backing up slowly until you feel a "BUMP". At this point the king pin should be fully engaged in the jaws of the fifth wheel and the lock mechanism should be locked shut. Refer to the Owner's Manual of your tractor to determine what type and model of fifth wheel you have on your tractor. This tractor manual will provide information on the method of verifying the jaws are fully locked shut on your fifth wheel. Figure 10 illustrates the lock on the Holland FW35 fifth wheel. Lode King uses the Holland FW35 series fifth wheel at the rear of the Lead trailer.

NOTE

Avoid using excessive speed or force to make this connection. Hitting the king pin too forcefully can damage it or cause it to crack. A damaged or cracked king pin is not safe to use, but once the connection is made there is no way to inspect the king pin for such damage.

IMPORTANT

Replace or repair any components as required.

IMPORTANT

It is recommended that a 'spotter' be used to help guide the driver when coupling to the Pull.

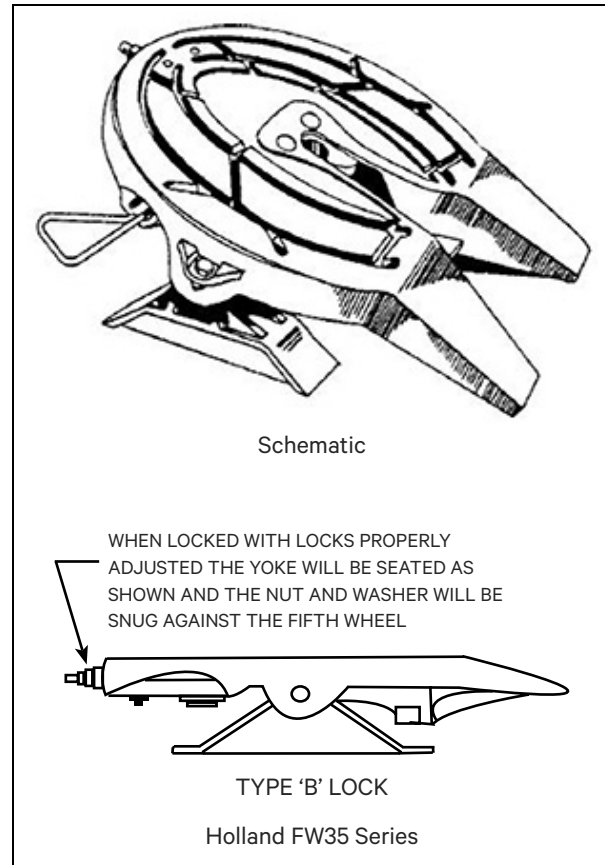

Figure 10 - Fifth Wheel



Figure 11 - Connections (Typical)

SECTION 4 – OPERATION GUIDELINES

5. Before connecting the air lines to the trailer check the security of the fifth wheel to the king pin connection by trying to drive the tractor forward slightly. The trailer parking brakes should remain engaged, preventing the trailer from rolling. If the fifth wheel connection is secure the trailer parking brakes will resist moving. Conversely, if the connection is NOT secure the trailer will remain stationary and the king pin will slide back out of the fifth plate. Reference Figure 12.
6. After verifying the trailer is locked onto the tractor fifth wheel, the weight should be lifted off the trailer landing gear. Crank up the landing gear to the fully retracted position and stow the crank hand.
7. Before attaching the tractor or Lead gladhands to the trailer check for dirt or debris and clean as necessary. Positively connect the tractor or Lead gladhands to the trailer. The gladhands are color coded **BLUE** and **RED** to avoid incorrect connection. Connect the blue gladhand (service brake line) of the tractor or Lead to the blue gladhand on the trailer. Similarly, connect red to red (emergency/supply brake line). Reference Figure 12. We will confirm brake function a few steps later on, to prove that the air lines are not connected backwards.
8. Check for dirt and debris in or around the electrical plug. Clean as necessary and then plug the tractor or Lead power cord into the trailer. Ensure the safety catch on the lid of the plug has engaged the male plug to prevent it from accidentally coming loose or disconnected.

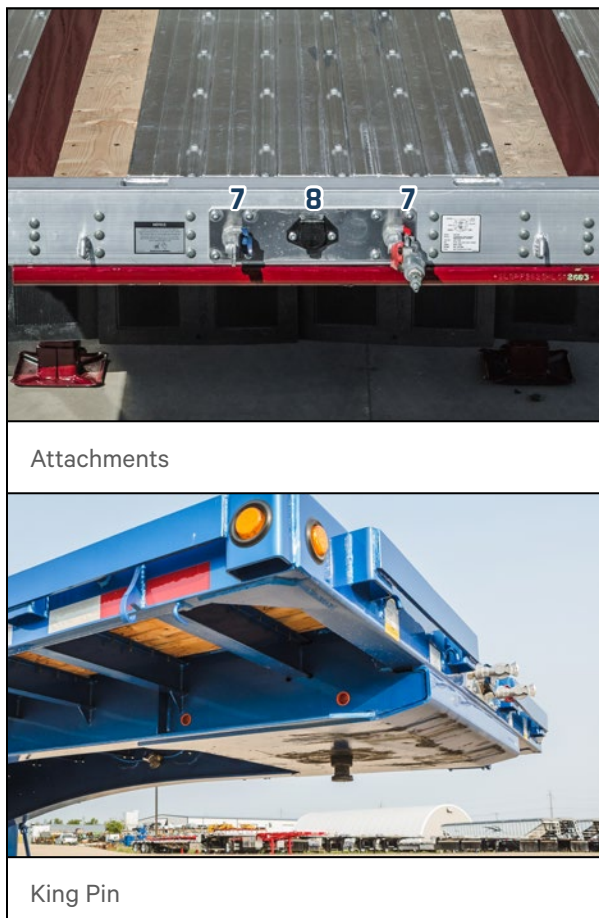

Figure 12 – Connecting (Typical)

9. Check the routing of the air and electrical lines to ensure they are not tangled and have sufficient slack to allow turns without pinching, kinking or tugging on the lines.
10. While the air tanks on the trailer are filling from the tractor or Lead, it is a good time to do a walk around check to verify that all the lights on the trailer are working.
11. Once the air tanks on the trailer are up to pressure the trailer brake function can be checked. Keep in mind, if the gladhands happen to be connected backwards, the trailer air tanks will not be filled. In this case it will be impossible to release the parking brakes on the trailer.
12. Release the parking/emergency brakes on the tractor and trailer(s). Drive forward a short distance while observing the trailer wheels in the rearview mirror. If the air tanks have filled and the park brakes have released, the trailer(s) should roll freely. Conversely, if you see the trailer tire skid or are sluggish to turn, the parking brakes are not fully released. Wait a few more minutes to allow sufficient air pressure to accumulate in the trailer tanks. If you stand next to the trailer, you may be able to hear the air flowing to the tanks.
13. If more time to fill the tanks does not get the parking brakes to release, double check the gladhand connections to verify they are correctly connected. If this still does not work, have a qualified mechanic check the situation and determine what is wrong.
14. After verifying the parking brakes have released, test the function of the service brakes. While driving ahead slowly apply the trailer parking brakes independently from the tractor using the trailer brake controller in the tractor cab. You should immediately feel the trailer service brakes engage. If this check fails and you cannot feel the brakes working, DO NOT put the trailer into service – something serious may be wrong. Have a qualified mechanic check for problems and ensure the trailer brakes are working properly before venturing out onto the road.
15. Perform the normal daily pre-trip inspection on the trailer. The steps in this pre-trip inspection are covered earlier in this manual, in Section 4.3.

4.5.2 - UNCOUPLING PROCEDURE

Disconnecting from the trailer is the same as for any normal semi-trailer. Proceed as follows:

1. Once a suitable parking spot is established, set the parking brakes on the tractor only.
2. Dump the air out of the trailer suspension air bags. Use the half turn valve in the air gage box to do this. Allow sufficient time for the air ride suspension to settle out. There are rubber bumpers inside each air bag and once the air pressure is released the weight of the trailer frame will come down to rest on these bumpers.
3. Crank down the landing gear legs until they start to take weight off the upper coupler.
4. Once the trailer suspension is fully exhausted of air, “dynamite” the trailer parking brakes to engage the brakes.
5. Disconnect the electrical cord and both gladhands at the front of the trailer.
6. Release the fifth-wheel lock on the tractor.
7. Slowly drive the tractor forward. The pick-up throat on the trailer will slide down the fifth wheel of the tractor until the landing gear legs contact the ground and begin to accept weight.
8. Stop to confirm the trailer is free of the tractor.

**THINK SAFETY!
WORK SAFELY!**

4.5.3 - UNCOUPLING THE PULL

Disconnecting the Pull is virtually the same procedure as the lead from the tractor. The Lead trailer must remain connected while the Pull is disconnected.

1. Once a suitable parking spot for the Pull is established, set the emergency/parking brakes on both the tractor and the trailers.
2. Dump the air out of the suspension air bags on the Pull. Allow sufficient time for the air ride suspension to settle out. There are rubber bumpers inside each air bag. When the air pressure is fully released for the suspension, the weight of the frame will come to rest on these bumpers.
3. Crank down the landing gear legs until they start to take weight off the upper coupler.
4. Open the lid on the electrical nose plug enough to free the safety catch and unplug the electrical cord from the Lead trailer.
5. Disconnect both glad hands on the air lines from the Lead trailer.
6. Release the lock on the fifth wheel of the Lead trailer.
7. Slowly drive the tractor forward. The nose of the Pull will slide down the ramps at the tail of the Lead trailer until the landing gear legs contact the ground and begin to accept the weight.
8. Stop and confirm the Pull is free of the Lead trailer.

**THINK SAFETY!
WORK SAFELY!**

4.6 - LOADING/UNLOADING THE TRAILER

The Flat and Step Deck Trailers are built in a variety of configurations and load capacity ratings. Refer to the specification section for a complete listing of their features.

From this list of available features the trailer owner must familiarize themselves with the particular features actually included on their specific unit. The following sections describe the use of all of these features, however, your trailer may not be so equipped.

4.6.1 - LOAD RATING

Each Flat and Drop Deck Trailer has a VIN tag affixed to the roadside main beam near the landing gear mount. This tag provides the rated Gross Vehicle Weight Rating (GVWR) of the trailer. The GVWR is defined as the weight of trailer plus its payload. All operators are responsible to know what they are loading and must ensure the GVWR is never exceeded.

The VIN tag also provides the Gross Axle Weight Rating (GAWR) for each individual axle on the trailer. The GAWR is the structural capacity of the lowest rated member of the axle components, i.e. suspension system, hub wheels, drums, rims, bearings, brakes, tires, etc. Do not exceed. All operators are responsible to ensure this axle rating is never exceeded.

The tractor selected to pull a Flat and Step Deck Trailer must also have a load rating matched to the trailer and load. Never use a tractor that is under-rated for the trailer and load being hauled.

 **WARNING**

Over loading a tractor or trailer is dangerous. Premature equipment failure or loss of control in operation may result. Either of these conditions can lead to serious injury or death of the operator, as well as bystanders.

4.6.2 - LOADING/UNLOADING

The Flat and Step Deck Trailer models are designed to be versatile and can be loaded and unloaded from either side.

Features and considerations for loading and unloading are as follows:

1. All Flat and Step Deck Trailers are equipped with air suspensions. Loading and unloading must be done when the air is exhausted from the suspension, sometimes called “dumping the air”. Failure to do this can cause damage to the air bags and shock absorbers on the trailer. The valve to control the air suspension is a simple half-turn ball valve located in the air gage box on the roadside of the trailer. Figure 13 shows the valve located at the top of the box and marked with the label “Air Bag Dump Valve”.



Figure 13 – Air Gage Box

The “NORMAL” position activates the air suspension, lifts the frame of the trailer and prepares the suspension for use on the highway. The “DUMP” position, when selected, isolates the air bags on all axles from the air supply and vents air in the bags.

DANGER

CRUSH HAZARD

Ensure all personnel are clear of the trailer when dumping the air as the trailer frame will settle and lower until the rubber bumpers inside the air bags arrest the lowering motion. The trailer settling can pose a serious crushing hazard causing serious bodily injury and death.

Do not operate the trailer on the road with the air dumped from the suspension regardless of whether the unit is loaded or empty. Doing so causes damage to the axles and if this condition were allowed to persist, could lead to breaking an axle.

2. The Lead trailer is designed to operate with a specific coupler height. Ask your dealer to provide this valuable piece of information for your specific trailer. Always make sure the tractor is matched to the trailer.

4.6.3 - LOAD LOCATION AND SECUREMENT

Where the load is located on the deck of the trailer has a large affect on the weight distribution and axle group weights of the tractor/trailer combination. Placing the load farther forward on the deck shifts more weight onto the nose of the trailer and consequently the tractor drive axles. Experience is invaluable when determining where to place the load.

Avoid overloading the trailer and associated equipment. Know your trailer load limits and plan your trips so overloading is not necessary. Each trailer has a load rating, a Gross Vehicle Weight Rating (GVWR) and a Gross Axle Weight Rating (GAWR). It is a straight forward matter to plan your load(s) so none of these ratings are ever exceeded.

WARNING

*An overloaded trailer creates many possible hazards, from damaging the structural frame of the unit to dynamic issues related to braking and turning. Overloading may lead to serious injury or death. **DO NOT OVERLOAD!***

Always position concentrated loads on main beams or on planks to transfer load to main beams to prevent damaging deck and support members.

Properly securing the load to the trailer deck is also critical to maintaining safety while the trailer is in motion. The North American Cargo Securement Standards provide extensive information on safe methods and techniques for securing a variety of load types. Go to the website of the Canadian Council of Motor Transport Administrator (CCMTA) at ccmta.ca or the Commercial Vehicle Safety Alliance (CVSA) at cvsa.org for all the details.

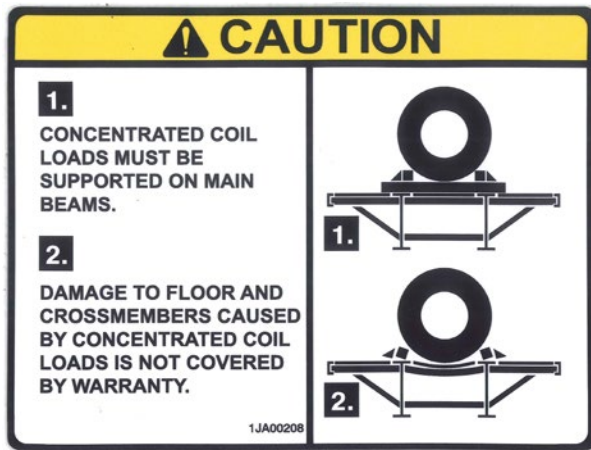

Figure 14 – Safety Sign

4.6.4 - LOAD SECUREMENT

Load securement provisions are provided along both sides of the deck. Winches and opposing J-hooks are installed for the application of 4" webbing straps. Similarly, chain pockets are welded to the outside beam on each side. It is the operator's responsibility to select the size and quantity of load securement devices for each load being hauled.

! WARNING

Improper load securement can lead to the load shifting/moving while in transit, or even coming right off the trailer. This is an extremely dangerous condition particularly for nearby people and other vehicles. ALWAYS TIE THE LOAD DOWN ADEQUATELY using properly rated equipment in good working order.

Securement provisions include but are not limited to:

1. Chain anchor
 - a. chain pull out on deck.
 - b. attach to stake pocket.
 - c. attached to pipe spool.
2. Pipe spool.
3. Winch.
4. J-hooks.

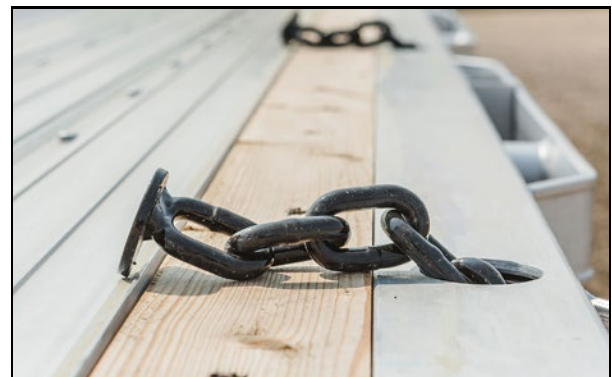

Chain Pull Out

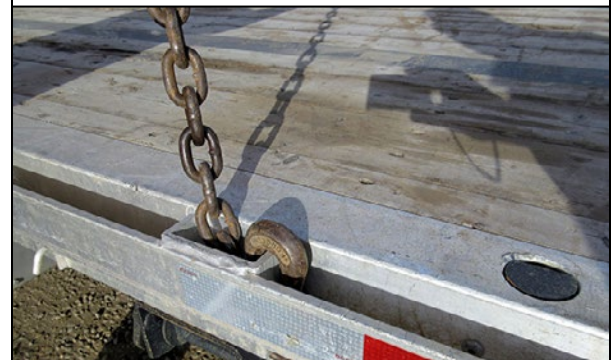

Stake Pocket

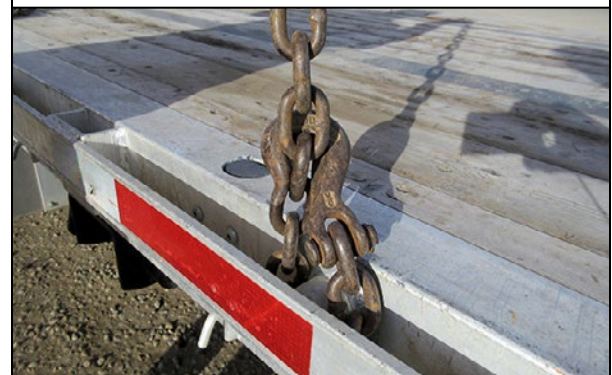

Pipe Spool

Figure 15– Chain Tie Downs (Typical)



Figure 16 –Flat Hook (Typical)



Figure 17 – Winch / J-Hook

4.7 - TRANSPORTING

After following the foregoing instructions, your trailer unit is ready to operate. Although all operating instructions are common sense, it is wise to review them periodically to refresh your memory. Good operational procedures result in a safe workplace for the operator who uses them.

4.7.1 - OPERATING INSTRUCTIONS

Since this equipment can be used in a variety of conditions, it is difficult to give instructions appropriate for all applications. However, these general guidelines apply to all situations:

1. Ensure that the trailer is securely attached and locked into position.
2. Ensure that the air lines are securely connected and that they have sufficient slack for turns.
3. Ensure that the brakes are properly adjusted and functioning.
4. Ensure that the electrical harness is securely attached and all lights and conspicuity tape are clean and operating.
5. An optional retractable clearance light package is available if transporting wide loads. Remove the lock pin, slide mount out and repin when transporting. Retract and pin when not required.
6. DO NOT drink and drive. Do not allow others to drink and drive.
7. DO NOT text or use a cell phone while driving. Do not allow others to text or use a cell phone while driving.
8. Only use 'hands free' system when making calls when behind the wheel.

9. DO NOT drive when under the influence of drugs. Do not allow others to drive while under the influence of drugs.

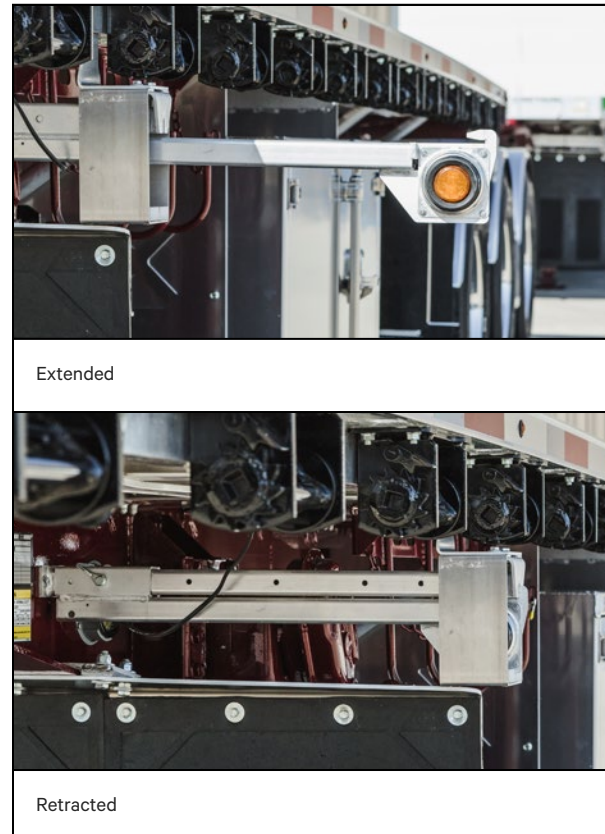

Figure 18 – Optional Clearance Lights

4.7.2 - BRAKING GUIDELINES

Safe, reliable and trouble-free operation of your trailer requires that the brakes be maintained in good operating condition at all times and the driver follows good apply techniques when driving. The improper use of brakes by the driver can contribute to shorter brake component life, result in system malfunctions and cause poor tire wear patterns. The following list summarizes some basic operational guidelines for the driver.

1. Check the function of the brake system before starting a trip.
2. Maintain a safe vehicle speed at all times. Slow down for rough road or slippery surface conditions, winding roads or congested areas.
3. Always provide sufficient vehicle spacing on the road to allow for a safe stopping distance.
4. Apply brakes gradually to produce an even deceleration until the vehicle is stopped.

5. Watch traffic patterns ahead. Anticipate pattern changes that could result in an emergency. Apply the brakes gradually in sufficient time to produce a controlled stop.
6. Shift to a lower gear to use engine compression as the retarding force when going down steep grades.
7. When travelling on a long downgrade, apply light steady pressure, as this will result in better vehicle control and reduce chance of overheating the brakes.
8. Dry the brakes by applying them several times after going through water.
9. Release the brakes just before going over railroad tracks or other rough conditions. By allowing the wheels to turn over rough road surfaces, there will be no shock loads to the brake system components and the possibility of flat spotting tires will be reduced.
10. Wet, icy or snow-packed surfaces require special care.
11. Use wheel chocks, apply trailer and tractor parking brakes and place tractor in low gear when parking the unit.
12. Allow drums to cool prior to application of parking brake to minimize potential for drum cracking.
13. Fanning or repeated on/off brake applications will drain system air reserves which could result in an insufficient air supply should an emergency occur.
14. Hard or panic stops can overheat the linings and drums. Overheating will cause brake fade. Severe overheating and fade can result in the complete loss of braking capability. This will substantially reduce the expected life of brake components and possibly the operator.

NOTES

Tire wear patterns indicate the trailer condition that cause the wear. Refer to the websites of tire manufacturers to review wear patterns plus their cause. Correct the condition before changing tires to prevent a repeat of the wear.

4.7.3 - TIRES

When operating the trailer, it is the responsibility of the driver to check the tires frequently. Inflation pressures, wear patterns and matching are critical parameters that must be monitored. The following factors affect tire care:

1. **Inspection frequency:** Tires should always be checked before the start of a run. It is also a good practice to check the tires at each rest period during the day. When a driver hears unusual noise or experiences unusual handling characteristics, the first item to check is the tires. Problems found early can help avoid more serious problems later on. Always correct the cause of the tire wear problem before proceeding.
2. **Inflation pressure:** Tires should always be operated at a specific pressure. The tire is designed to run with the full width of the tread flat on the contact surface. Operating at other than specified pressures will change the tread contact patterns and can dramatically shorten tire life. In addition, under-inflated tires will run hotter and can lead to blow-outs. Tire pressure must be matched on a pair of duals to avoid pre-mature and irregular wear.

Check tire pressure when the tire is cold. A hot tire can read as much as 20 psi higher than a cold tire. For proper inflation pressures, refer to the tire manufacturers specifications. The cold inflation pressure rating shown on the VIN tag corresponds to the GAWR of the axles. It may or may not be the optimum pressure for your tires based on the work you are doing with your trailer.
3. **Tire matching:** Do not mix ply types on the same axle. Their operating characteristics are different and will lead to uneven tire loading, rapid tire wear and adverse handling characteristics. Matching also includes combining tires that have the same amount of tread remaining. A tire with more tread has a larger rolling radius and will have to carry a heavier load. The best performance will be obtained when the rolling radius is within 1/8" for all tires on an axle.

4.7.4 - TIRE INFLATION SYSTEM

Correct tire inflation pressure is such an important issue for safe operation of the trailer as well as achieving optimum tire life. To address the need for constant monitoring of tire pressure the Hendrickson Tiremaax Pro tire inflation system is now an available option on the trailer. To identify whether your trailer is so equipped, visually inspect the wheel ends. The tire inflation system uses hoses plumbed off the centre hubcap and connected to the valve stems on the wheels. See Figure 19.



Figure 19 – Tire Inflation Hoses

In addition to these hoses, the main control box for this system can be found near the running gear of the trailer. See Figure 20. The green synflex air lines are further evidence that your trailer is equipped with this Tiremaax system.

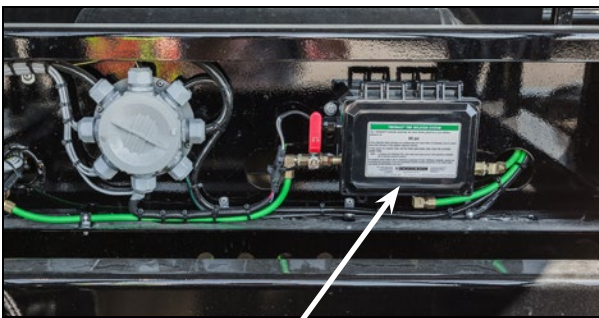

Figure 20 – Tire Inflation Control Box

The operation of the Tiremaax system requires no input from the operator. The Tiremaax controller is designed to take air from the trailer air tank when needed and add it to any tire that is below the set point pressure of the system. Additionally, the Tiremaax controller monitors tire pressure constantly and should tire pressure increase (due to heat input) it will automatically let air out of the tires to maintain them at the desired pressure. The pressure set point for the

Tiremaax system is factory set and cannot be changed by the operator. If a change to the pressure set point is desired, contact your dealer to have this done.

A key feature of the Tiremaax system is that it pneumatically connects the two tires in a set of duals so they are always at exactly the same pressure. This is important so the pair of duals maintains the same overall circumference, thereby allowing them to roll at exactly the same revolutions per mile. This reduces or eliminates scuffing/scrubbing of tires that are not the exactly the same circumference, which in turn reduces tire wear and allows the tires to achieve optimum life.

A safety feature of the Tiremaax system is a set of built-in safety shut-off valves. If a catastrophic failure of a tire or supply hose occurs, a large sudden rush of air through the Tiremaax system will cause the shut-off valve for that particular tire to be activated, isolating that tire from the rest of the system. This prevents flattening all the tires on the trailer.

A warning light is included at the front road side of the trailer for the Tiremaax system. See Figure 21. This system is designed to add (or subtract) air to the tires in a very slow and controlled manner. If the demand for air supply moves above a preset threshold it will cause the warning light to come ON. If the light is illuminated it indicates something may need attention, such as a catastrophic failure or a tire with a slow leak. This situation should be investigated and dealt with immediately.

If you suspect something is amiss and want to manually check the tire pressures with a tire gage, this is still possible with the Tiremaax system. Unscrew the fitting which secures the tire hose onto the hubcap. A tire gage can be placed onto the end of this hose to get the pressure reading. Once the reading has been taken, remember to securely reconnect the hose to the hubcap by screwing the threaded fitting into the hubcap.



Figure 21 – Fault Light

4.7.5 - RUN-EMPTY AXLE LIFTS

Some trailers are factory equipped with an optional Run-Empty axle lift system. This system, where installed, is based on the idea that while running empty all of the tires are not needed to carry the empty weight of the trailer. By lifting some of the tires off the ground, rolling resistance and tire wear may be reduced.

To identify if your trailer is so equipped, simply look at the suspension hanger brackets on each axle. See Figure 22 below. The axles equipped with lifts have brackets welded to the forward side of the hanger brackets and have small air bags located there which perform the lifting function.



Figure 22 – Axle Lift

Note that this system is not intended to be used with a partial load in the trailer. The lifts are designed to be raised only when the trailer is completely empty.

The axle lifts are controlled by the ABS computer. The only intervention possible by the operator is to turn the lift function ON or OFF using the electrical switch in the air gage box. See Figure 23.



Figure 23 – Axle Lift

Once the operator activates the system no further intervention is needed. The lift system is equipped with a pressure sensor in the air ride system. This sensor provides a pressure signal to the ABS computer. Preset pressure levels are factory loaded into the ABS computer. When the low pressure reading is sensed, the ABS computer knows the trailer has been unloaded and sends a signal to a pilot valve to dump the air from the ride bags on the lifted axles and to direct system air pressure instead, to the lift bags. The axle is thereby raised.

Conversely, when a high pressure is sensed in the “down axle” the ABS computer knows that a load is being added to the trailer. It sends a signal to the pilot valve to cut the air supply to the lift bags and bring the ride bags back on line. The lifted axle(s) are restored to full load carrying mode. Provincial regulations require that a “Status Light” be included with this Run Empty Axle Lift system. When the light is “ON” it means the lift system has been activated. A decal will also be located near this light indicating that it is the axle lift system status light. See Figure 24 for pictures of the light and decal. This light and the decal will be located on the road side of the trailer near the rear of the unit.



Figure 24 – Axle Lift System Decal and Light

The axle lift control system that is included in the ABS computer is designed to lock out any change to the “UP” or “DOWN” commands while the trailer is moving. A command to raise or lower the lift(s) will only occur while the trailer is stopped and the wheels are not turning.

4.8 - FLIP-OVER BEAVERTAIL RAMPS

The beavertail option is available in a variety of configurations on step deck trailers. However, they all are designed to operate in the same manner. They are intended to be permanently attached to the trailer, or not easily removable. Each ramp is equipped with a double hinge arrangement to permit the ramps to sit flat on the ground for stability during loading and unloading of mobile machinery.

These beavertail ramps do not have a specific load rating, but rather, are matched to the trailer upon which they are connected. If the load being contemplated is suited for the load rating of the trailer, these ramps should also be suited to work with that load.

Due care and caution must be exercised when driving a machine or vehicle over this beavertail, onto the deck of the trailer. In many cases the vehicle being loaded will be as wide as the deck of the trailer, or may even hang beyond the sides of the deck. It is recommended to have a spotter on hand while loading to ensure the vehicle is not inadvertently driven off the side of the deck. This could result in a very dangerous situation where the loaded vehicle might tumble off the side of the trailer.

Before loading ensure any dirt, gravel, snow, ice or other loose debris is swept off the deck and beavertail.

Recommended use of the beavertail and ramps is as follows:

1. Park the tractor and trailer on flat even ground, suitable to stable loading or unloading.
 - NOTE: Do not attempt to load/unload when the trailer is disconnected from the towing tractor. This could result in an unstable situation where the front of the trailer could move uncontrollably.
2. Locate suitable wooden blocks, or an equivalent, under the rear bolster of the trailer, in line with the main beams of the trailer. See Figure 25 Exhaust the air from the air ride suspension so that the frame of the trailer comes down to rest on these blocks.
3. With the air out of the trailer suspension, engage the parking brakes to ensure the trailer does not roll forward during the loading/unloading activity.

4. Manually flip the ramps over so they sit flat on the ground. There should be no gap or space under the ramp – they should sit completely on the ground.
 - NOTE: the ramps are fairly heavy. It is recommended to stand beside the trailer while flipping the ramps so they do not hit you during this operation.
5. Perform the loading/unloading activity using due care and caution.
6. Once loading/unloading is complete, fold the ramps back up onto the tail of the trailer. The ramps may be secured using a load securement strap and a winch on the side rail of the beavertail.
7. Air up the suspension and stow the wooden blocks from the tail end.
8. Once the load is properly secured to the deck and the unit is ready to travel, disengage the trailer parking brakes. You should be ready to go.



Figure 25



SERVICE AND MAINTENANCE

This section provides information and recommendations on daily and periodical maintenance which if followed will result in safe and dependable operation of your trailer unit.

Ensure that all operators of the trailer are familiar with the operation and maintenance procedures and related safety information contained in the Owner's Manual.

Road safety begins with maintenance. Without proper maintenance, it is impossible for trailer safety to occur. Annual safety inspections, pre-trip inspections, post-trip inspections and preventative maintenance are all the necessary components for a proper maintenance program.

Trailer maintenance should be a priority with regular, scheduled, timely and well documented maintenance checks. Trailers with regularly scheduled maintenance programs consistently have a lower cost of ownership. Over the road breakdowns result in more cost than repairs made in a shop. Taking a pro-active approach to maintenance is key to controlling costs and to help ensure all safety and regulations guidelines have been met.



MAINTENANCE SAFETY

1. Read and understand all the information in the Owner's Manual regarding maintenance, adjusting and operating the trailer.
2. Stop the engine, remove ignition key and set the park brake before adjusting, servicing or maintaining any part of the trailer unit.
3. Review the Owner's Manual and all related maintenance, operating and safety information annually with the personnel who will be working with, maintaining or operating the trailer.
4. Do not attempt to maintain, adjust or service any part of the trailer while loading or unloading.

**THINK SAFETY!
WORK SAFELY!**

PERIODIC MAINTENANCE PROCEDURES AND ADJUSTMENTS

The safe and efficient operation of your trailer will depend a great deal on your diligence in following the maintenance and adjustment procedures outlined in this section. If you follow these recommendations, your trailer will work to its full potential. With adequate attention to regular and preventative maintenance your cost can be reduced significantly.

The various components and systems of your trailer will require your periodic inspections, maintenance and adjustments. Information is presented in this section to support that activity.

Every province in Canada and state in the United States requires that commercial vehicles, such as your trailer be subject to a full safety inspection at least annually. It is the law and Lode King fully supports this initiative. The information in this owners manual is intended to supplement and support such a safety inspection program. Nothing in this manual should conflict with it.

The Flat and Step Deck Trailer is designed for use in the general transport industry. The inspection intervals recommended here are based on this type of usage. If your trailer is used in frequent long haul usage it may be necessary to inspect more frequently to maintain an appropriate level of safety.

Maintenance procedures and recommendations follow, pertaining to specific components and/or assemblies used on your trailer.

WARNING

Do not drill or weld main beams!
Welding or drilling main beams will void any warranty and may result in catastrophic beam failure causing a serious accident, leading to injury or death.

1JA00320B

MAINTENANCE SAFETY

1. Set the park brake. Stop engine, remove ignition key before performing any maintenance, adjusting or servicing any part or component on a trailer unit.
2. Clear the area of all bystanders especially children, when carrying out any maintenance or making adjustments on the system or components on the trailer.
3. When it is necessary to remove the wheels from any axle on the trailer, ensure the vehicle is securely blocked or supported so it cannot shift or drop. These vehicles are extremely heavy. If they should fall on you serious injury and possibly death may result.

5.1 - ALTERATIONS TO THE TRAILER

MINOR ALTERATIONS

These should be made in accordance with good shop practices. Normally, minor alterations will not alter the rating shown on the trailer certification plate. A possible exception is the Gross Axle Weight Rating (GAWR). If components are substituted with ones that are of equal or greater capacity than those used at the time of manufacture, then the GAWR need not be altered. If components are substituted that have less capacity than those used at the time of manufacture, the GAWR on the certification plate must be lowered to a corresponding lower capacity.

MAJOR ALTERATIONS

No major alteration of a trailer should ever be made without first consulting the factory. Major alterations can affect the structural integrity of the trailer, and can alter the GVWR and void the trailer's warranty coverage.

THINK SAFETY!
WORK SAFELY!

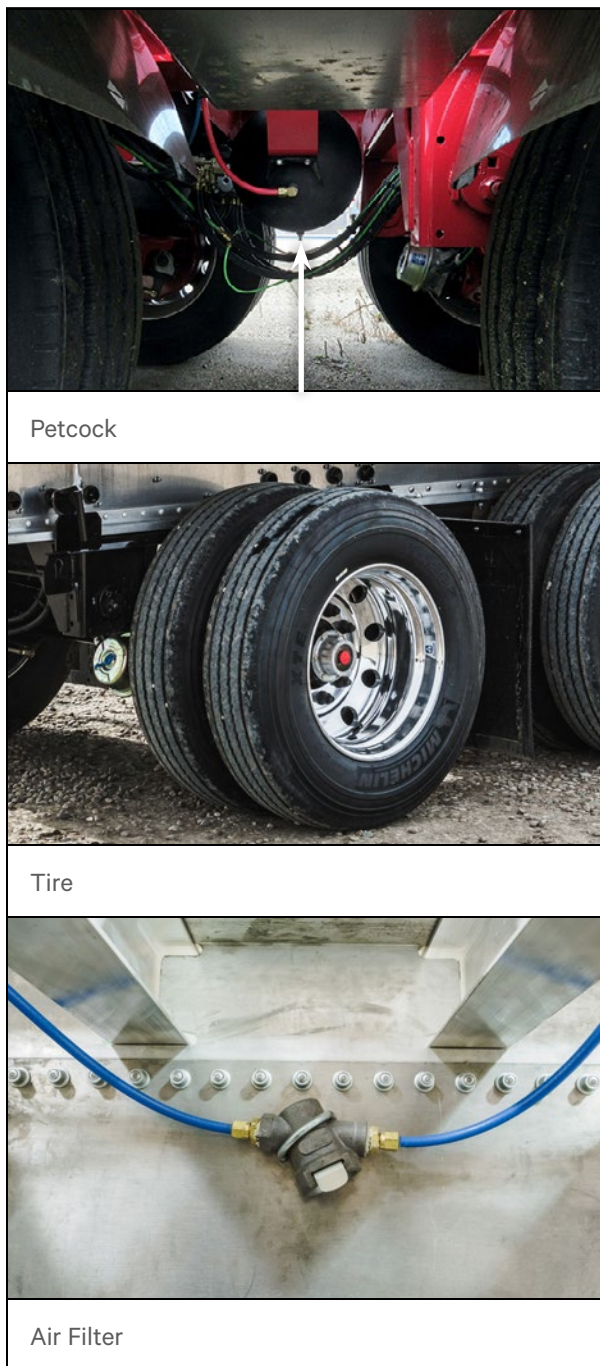

Figure 26 – Servicing (Typical)

INTERVALS

- a. Drain air tanks; check tire pressure: DAILY
- b. Grease the trailer: WEEKLY
- c. Clean the air filter and check wheel end lube level: MONTHLY

It may be necessary to adjust these intervals to suit the frequency of use of each trailer. Let experience help you judge if it is prudent to make a change.

NOTE

The brake component manufacturer recommends that the slack adjusters and S-cam tubes and bearings only need to be greased every 50,000 miles (80,000 km) or every three (3) months; whichever occurs first.

5.2 - TRIP SERVICING

The Flat and Step Deck Trailer is a durable piece of equipment and a simple servicing program, performed on a regular schedule, will allow the unit to give the owner many years of trouble free service.

1. Each air tank is equipped with a drain petcock at the bottom of the tank. Open the petcock briefly to drain any and all moisture from the tank. Each tank must be drained individually. Close the petcock firmly once all moisture is out of the tank.
2. Check the air pressure on each tire. Add air as necessary to any that are low on pressure. Visually check tires for signs of irregular wear patterns. Irregular wear on the tires may indicate a problem that warrants further investigation.
3. The air brake line is equipped with an in-line filter to trap debris. This filter is located along the roadside of the upper coupler assembly. Reference Figure 26. Remove the filter cartridge. Blow out any debris with compressed air or wash the cartridge with mild detergent and water. Ensure it is completely dry before reinstalling the cartridge in the filter body.
4. Most axles are set up with oil lubricated wheel ends and come equipped with the clear plastic centre in the hub cap. Visually inspect each to ensure the oil level is full, up to the inside ring in plastic window. If any have low oil level check for possible leaks; top up the oil level as needed.
5. Grease the unit at all zerk fittings. Specifically:
 - a. Slack adjusters.
 - b. Brake cam shaft tubes and bearings.
 - c. Fifth wheel on jeep.

Apply the grease judiciously; do not get carried away! Use a high quality lithium based extreme pressure grease throughout. When used in extreme cold climates a synthetic grease that remains workable at very low temperatures is recommended.

5.3 - KINGPIN AND UPPER COUPLER

Every Flat and Step Deck Trailer comes equipped with a solid mounted style kingpin. The pin cannot be removed and has no moving parts.

The upper coupler plate should remain flat for years of service. Inspect for any signs of damage or distortion.

The plate should not bow downward (convex) more than 0.25" anywhere within a 19" radius of the kingpin. Similarly, the plate should also not be bowed downward more than 0.125" anywhere within a 10" radius of the kingpin. The plate should not be bowed upward (concave) any more than 0.063" within a 19" radius of the kingpin.

These flatness tolerances are taken from Standard J700 published by the Society of Automotive Engineers (SAE).

WARNING

The trailer kingpin is made of a special, high strength, heat treated steel. DO NOT attempt to repair the kingpin by welding. This would completely destroy the heat treating, weakening the pin and creating a very real safety hazard.

Inspect the kingpin for wear, distortion, cracks, or any other signs of damage. The kingpin is not repairable. If it is damaged and not usable, talk to your authorized dealer about what repair action is needed.

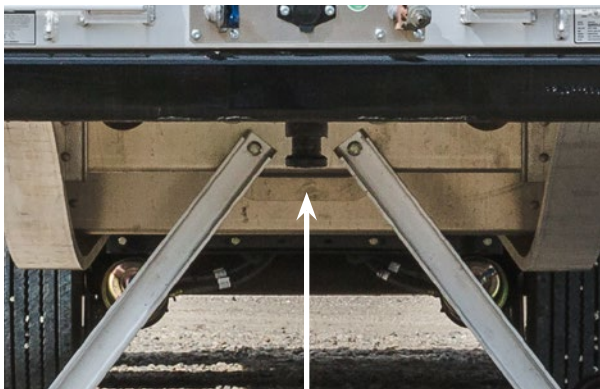

Figure 27 – Kingpin (Typical)

5.4 - SUSPENSION AND AXLES

5.4.1 - PIVOT CONNECTION

All Lead, Pull and single semi Flat and Step Deck Trailers are factory equipped with air ride suspensions. Lode King uses exclusively, suspensions manufactured by Hendrickson International. Hendrickson has a wealth of information available on their website at hendrickson-intl.com to assist with inspections and maintenance of their suspension products.

All deck trailers employ the Hendrickson Intraax suspension. These suspensions employ a rubber bushing in the trailing arm at the pivot point where the arm is connected to the frame bracket. Hendrickson has published three maintenance brochures, as follows, that describe in detail how to inspect this pivot connection and, if necessary, how to repair any damage. Go to hendrickson-intl.com and get your copy of:

- a. Brochure B106 – Pivot Bushing Inspection Procedure.
- b. Brochure L750 – Bushing Tube Spacer Inspection/Replacement.
- c. Brochure L427 – Replacement of Tri-Functional Bushing.

5.4.2 - RIDE HEIGHT SETTING

To ensure continued performance from the air ride suspension it is important to check that the axles are operating at the correct ride height. This check requires a tape measure. Figure 28 illustrates how to measure the ride height. All Lead, Pull and single semi trailers use a 14" ride height suspension. Step deck trailers use a 6 ½" ride height with 255/70R22.5 tires or 5 ½" ride height with 245/70R17.5 tires..

NOTES

Ride height must be set on the axle equipped with the ride height control valve. Every trailer has one primary ride height control valve. This valve controls the air pressure in all air bags on all of the axles. By having one common supply of air to all air bags it ensures that they all carry exactly the same weight. Some trailers equipped with the Run-Empty axle lift system may have a secondary ride height control valve that is activated by the lift function.

To check the ride height of the suspension proceed as follows:

- a. Park the trailer on a flat, level surface.
- b. Chock the wheels on the trailer so the unit cannot roll.
- c. Check tire pressure of the tires on the axle being measured. Adjust tire pressure to suit the tire manufacturer's recommendations.
- d. The trailer air system must be charged to perform this check. The supply air can be from a towing tractor or connect a shop air supply to the emergency glad hand to pressurize the air tanks.
- e. The ride height control valve is intentionally designed to be slow acting in order to reduce air consumption in normal service. After the air supply is connected allow sufficient time for the system to fill and for the ride height valve to stabilize.

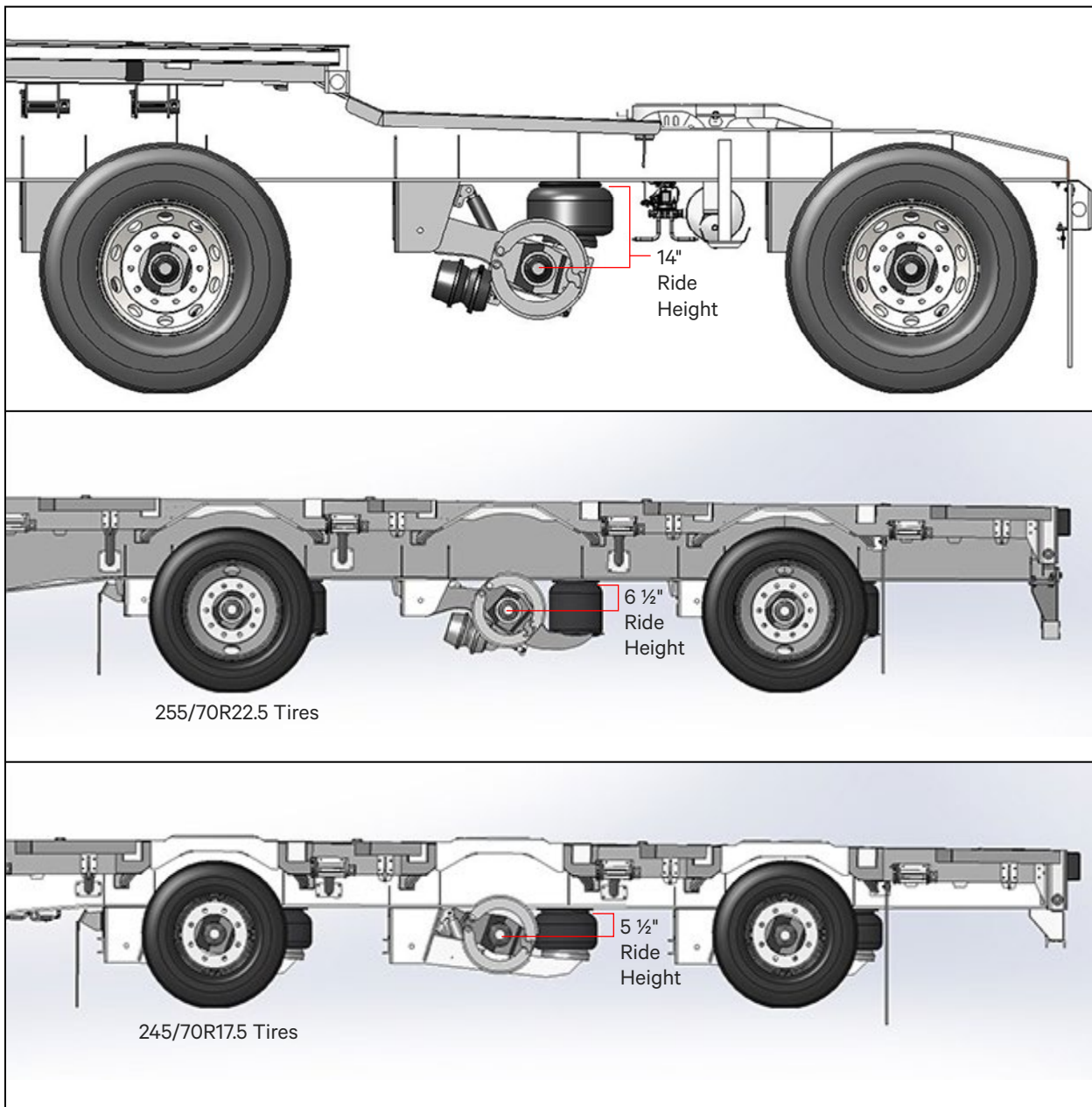

Figure 28 – Suspension Ride Height Setting

- f. The trailer emergency/parking brakes must remain released while performing this check. Close the air suspension dump valve in the air gage box to allow the air suspension to function normally.
- g. Ride height is defined as the distance from the suspension mounting surface (bottom of trailer frame) to the centre of the axle tube. Since there is no way to measure to the centre of the axle, simply measure to the top of the axle tube and then add half the diameter of the tube. Most Flat and Step Deck Trailers use 5 3/4" diameter axles, therefore, add 2 7/8" to the tape measured distance to arrive at your actual ride height. See Figure 28.



Figure 29 – Ride Height Mechanism

- h. If the ride height is incorrect it can be adjusted by changing the length of the linkage rod of the ride height control valve. This rod connects the arm on the valve to the trailing arm of the suspension. Disconnect the linkage rod from the arm of the valve. By hand, raise the arm to increase ride height or lower the arm to decrease it. Allow sufficient time for the valve to stabilize at the new setting and then re-measure the ride height. Repeat this step until the desired ride height is achieved.

NOTE

The air system is equipped with a pressure protection valve that prevents any air from being introduced into the air suspension until there is at least 80 psi of pressure in the air tanks. Ensure the air system is fully pressurized before trying to adjust the ride height.

- i. Once the correct ride height is achieved, adjust the length of the linkage rod to match and reconnect the linkage to the arm on the valve.

DANGER

CRUSH HAZARD

It will be necessary to slide under the trailer to gain access to the ride height valve and linkage rod. While moving the arm on the ride height valve it is possible to lower the entire frame of the trailer. Exercise extreme caution to avoid getting crushed by the trailer frame. Performing this work in a shop equipped with a pit is recommended to avoid this potential danger.

- j. To verify and double check ride height, ensure nobody is under the trailer, then dump the air from the suspension using the dump valve in the air gage box. With the shop air still connected and air tanks fully charged, close the dump valve and allow the system to pressurize the air bags. Once the suspension has reached ride height and the ride height valve has stabilized, remeasure the ride height to verify that it is correctly set.

5.4.3 - AXLE ALIGNMENT

Improper axle alignment with the vehicle frame or chassis may cause excessive tire wear and vehicle dog-tracking.

Proper axle alignment is a vital part of your operation (maintenance) and should be checked on a regular basis.

Each trailer is checked for correct axle alignment during final finish inspection procedures before leaving the factory.

This alignment procedure can be carried out by your dealer. However, the procedure is not overly complicated and can be performed as described herein.

Procedure:

1. The kingpin has a dead-center mark on the bottom side. To assure proper alignment a steel tape measure should be run from the center part of the kingpin to an identical location on either side of the front axle.

(A small rigid hook in the shape of a question mark made of 1/4" bar stock will facilitate this alignment inspection. A steel tape can be attached to the end and this tool hooked over the king pin).

2. Roll the vehicle back and forth over a level floor a few times to permit the connecting linkage to properly position itself and to center front and rear wheel track.
3. Level the trailer both along its length and across the width.
4. Measure the distances "A" and "B" from the kingpin to the forward axle as show in Figure 30 below. These distances must be within 1/8" (3.2 mm) of each other. After aligning the front axle with the trailer kingpin, then align the centre axle with the front axle, then align the rear axle to the centre axle.

NOTE

The actual dimension is not important. Compare the two dimensions side-to-side and ensure that they are the same within the specified tolerance.

5. Measure the distances "C" and "D" between the front and centre axles. These distances must be within 1/16" (1.6 mm) of each other. Also measure these distances between centre and rear axle.

The gauge sketched in Figure 30 simplifies measuring the inter-axle distances "C" and "D". The gauge can be made of drill rod or pipe fittings. The material and details are not important as long as the parts are rigid and true. The pointer arms of the gauge should be parallel and held in the same plane.

If any of these measurements do not fall within the stated limit, the vehicle suspension should be thoroughly inspected for loose, worn, or broken connecting and supporting parts. Adjustments in the suspension and the replacement of worn or broken parts should be made to bring the axles into alignment.

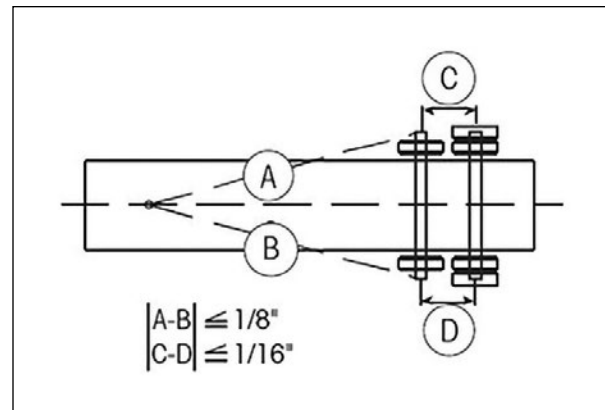

Figure 30 – Measurement Schematic

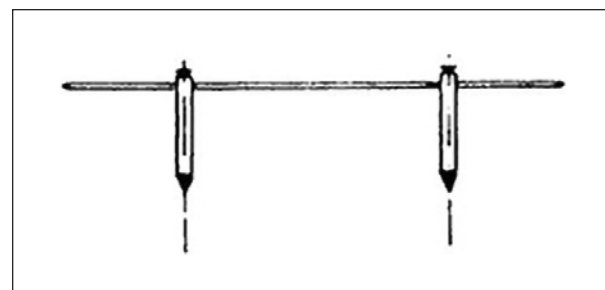

Figure 31 – Gauging Tool

The limits of 1/16" and 1/8" appear very small in comparison to the overall dimensions of the vehicle, but they are recognized as the maximum permissible variation. The relatively small size of these limits makes it important that measurements be accurate.

Failure to keep the axles properly aligned may cause tire scrub and suspension components strain.

If axle alignment is found to be outside the tolerances listed here, adjustment is possible, but will require special tools and replacement parts to perform. Hendrickson has published brochure L579 that describes the axle alignment procedure in detail. Go to hendrickson-intl.com to get a copy of this brochure.

IMPORTANT

Replace or repair any components as required.

THINK SAFETY! WORK SAFELY!

5.4.4 - FASTENERS

Threaded fasteners are used in several locations on the Hendrickson HT series suspensions. As part of regular maintenance these fasteners need to be checked to ensure they remain tight. Hendrickson provided brochure B31 that summarizes the correct torque values for all of these fasteners. Go to hendrickson-intl.com to get a copy of this brochure.

These torque values are repeated here in Table A

Suspension Arm Pivot	Bolt Shear type: do not torque
Axle U-Bolts	500 lb ft +/-25
Air Bag Bolts, Lower	45 lb ft +/-10
Air Bag Nuts, Upper	90 lb ft +/-10
Shock Absorber Bolts	225 lb ft +/-10

Table A

The bolt which secures the suspension trailing arm to the frame hanger bracket is specially designed for this application. A special TORX socket is needed to engage the head of the bolt. The bolt is tightened until the Torx head shears off the fastener. When this occurs the pivot bolt is correctly torqued and shall not come loose. Additional information about this pivot bolt connection is available in Hendrickson brochure L1072 Pivot-Connection Fastener Information. A copy is available at the Hendrickson website.

During periodic maintenance inspections place a wrench on the nut of this pivot bolt and using a reasonable amount of force, ensure the bolt is still tight. You should not be able to turn the nut on the bolt. If this pivot bolt has come loose it will need to be replaced as outlined in Hendrickson brochure L1072. The replacement parts are available from your authorized dealer.

5.4.5 - AIR BAGS

The air bags or air springs in the suspension seldom develop problems unless they are rubbed, scuffed or punctured. If a bag should fail in service you will hear the air pressure escaping. In this event the trailer frame will settle down until it comes to rest on the rubber bumpers located inside each air bag. The trailer may be driven at a reduced speed in this circumstance to get it into a repair facility. Identify and correct the cause of the problem before continuing. **DO NOT** continue to use the trailer without air in the suspension. See Figure 32 below.

5.4.6 - SHOCK ABSORBERS

Shock absorbers are included on each axle to absorb vibratory energy from the axle, thereby improving control of the trailer. As long as the shock absorbers are not leaking they should continue to work properly. If a shock begins to leak there will be definite streaks of oil running down the body of the shock. Replace the shock absorbers if they are leaking. Replacement parts are available at your authorized dealer.



A – Air Bag

B – Shock Absorber

Figure 32 – Air Bags (Typical)

5.4.7 - CONTROL VALVE

The air suspension is equipped with a pressure gage and a dump valve, both located in the air gage box. This box is located in the road side siderail just forward of the front axle. See Figure 33.

The air must be exhausted from the suspension for loading in a stationary application and when unloading. Turn the handle on the dump valve half a turn to open and exhaust the air. Turn it back to close the valve and recharge the suspension air system. Recall that the air suspension system is supplied through a pressure protection valve that will not allow air into the suspension until there is at least 80 psi of air pressure in the air tanks.

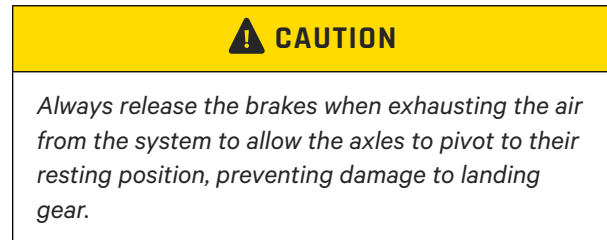

Always exhaust the air from the suspension before parking the trailer, regardless of whether it is loaded or unloaded.

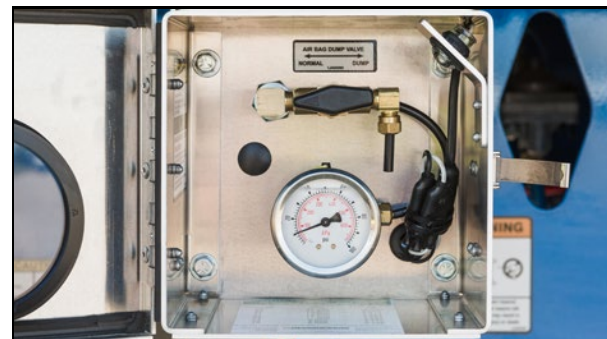

Standard



Steerable Axle

Figure 33 – Air Dump Valve with Gauge

5.5 - WHEEL ENDS

All Flat and Step Deck Trailers are equipped with conventional cast hub that feature 10 wheel studs and integral hub pilots to positively locate the dual wheels on the hub. Each hub is mounted on the axle spindle using traditional tapered roller bearings. See Figure 35. In most cases an oil bath is used for lubrication, however, grease style lubrication is an available option. A simple visual inspection will determine if your trailer has the more common oil lubricant or the grease lubricant. The hub cap used for the oil bath has a transparent sight glass at its centre, where you can visually check the oil level in the wheel end. See Figure 34.

The axles use the common HN spindle, see Figure 35, in most cases, but the HP spindle is an available option. With the HN spindle the outer bearing is slightly smaller than the inner bearing and the spindle is tapered to accommodate this smaller outer bearing. On the HP spindle the outer bearing is the same size as the inner bearing so the bearing seats on the axle spindle are the same size or are “parallel”.

On trailers built prior to 2016 the nut used to retain the wheel bearings are normally a double nut system with a lock washer sandwiched in between and a set screw locking feature. The one piece Pro-Torq nut retaining system is an available option. See Figure 36B and Figure 37. On trailers built in 2016 and subsequent the Hendrickson Precision spindle nut is employed. See Figure 36A.



Figure 34 – Hub Cap

5.4.8 - SEALS

The wheel seals are a very important part of the wheel and assembly. Our trailers are built using National Gold seals. An available option is the Stemco Guardian seal.

All of the wheel seals should be inspected for leakage. This will be most easily accomplished after the wheels and brake drum are removed. However, it is also possible to view the seal area by removing the dust shield from the axle, in board of the brake drum.

Visually inspect for signs of leakage. If the seal is leaking you will likely find a puddle of wheel end oil collecting in the brake drum. Once this oil has been spread onto the brake linings from the drum, the brake linings will be ruined. Find the source of the leakage problem, repair it, then replace the brake linings with new pieces before re-assembling the wheel end and putting the trailer back into service.

NOTE

It is normal and acceptable for a thin film of oil to form on the exterior surface of the seal lip. This light film of oil will attract dust from the brake linings. This is normal. However, if there is enough oil present that it can start to drip off the seal lip, this is the beginning of a leaky seal situation.

Oil leaking from the seal may indicate a failure of the seal. However, it may be just a symptom of a larger problem. For example, if excessive play is present in the wheel bearings it will allow the hub to “wobble” as it rotates in service. The seal has no way to compensate for excessive hub movement and will not be able to prevent oil from passing; a leak happens. If a leaking seal is found it is critically important that the root cause of the problem is pin pointed and diagnosed before pulling the wheel end apart. Check for excessive end play in the bearings as outlined in the following section. Verify that the hub rolls smoothly by hand; that the bearings are not rough, grinding or sticking. If the hub does not roll smoothly it may indicate a bearing failure has happened.

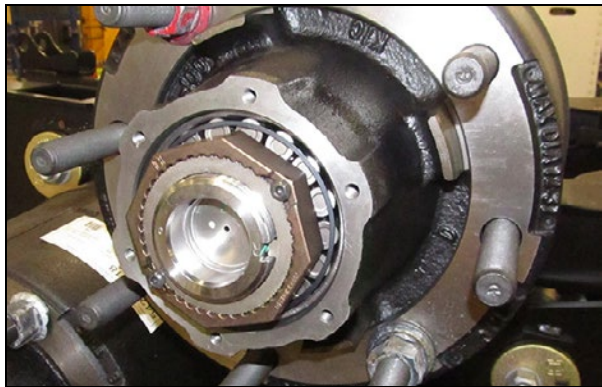
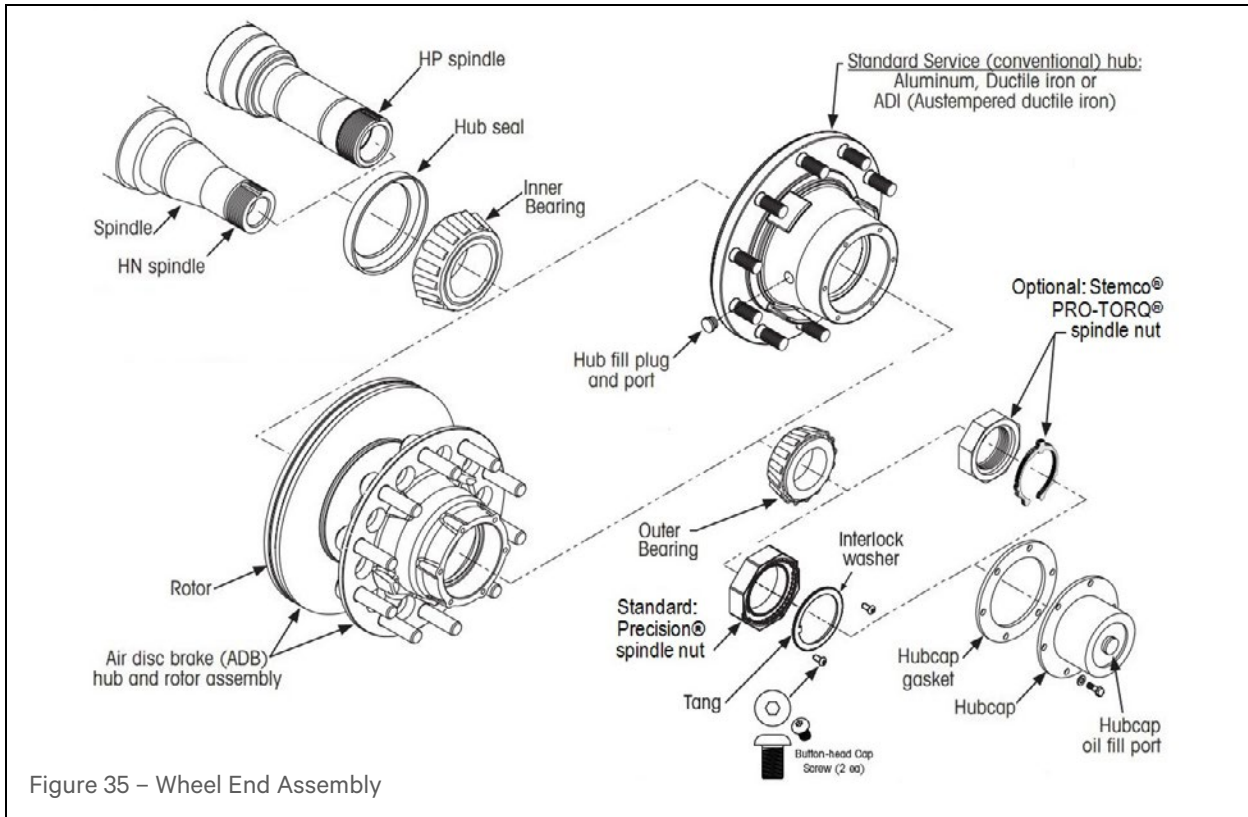

Figure 36A - Precision Nut

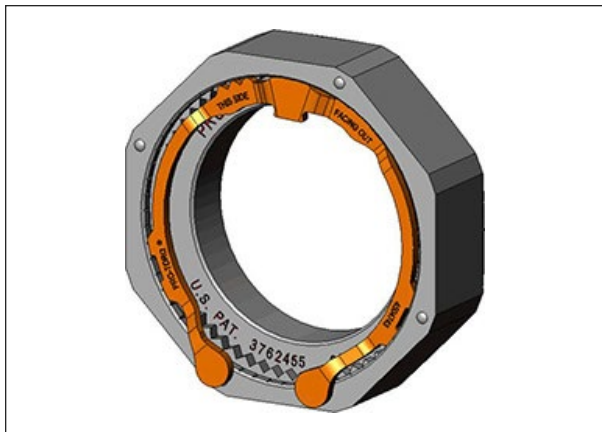

Figure 36B - Pro-Torq Nut (optional)

This Vehicle Equipped With

**STEMCO®
PLATINUM
PERFORMANCE
SYSTEM**

- Guardian® HP Wheel Seal
- Pro-Torq® Spindle Nut
- Sentinel® Hub Cap

For Maintenance Questions
Contact Fleet Supervisor
or
STEMCO LP



1-800-527-8492

Figure 37

Inspect for any signs of damage or foreign material in the wheel end.

Water in the oil of the hub can quickly deteriorate the ability of the oil to do its job. Additionally, moisture can create corrosion on the bearings and seal. Any such corrosion will quickly lead to failure of the bearings and seal. If you suspect water in the oil, the “CRACKLE” test may be applied to verify whether moisture is present. For details on performing the CRACKLE test go to stemco.com and download their brochure TQM2007. The basis of this test is the fact that water boils at a much lower temperature than the oil. When heated to 300 degrees fahrenheit the water will turn to steam and create bubbles in the oil. If allowed to get hot enough the steam bubbles will begin to “crackle”. Do not use oil that has been contaminated with water. Drain it and replace the oil with new, clean oil.

5.5.1 - WHEEL BEARING CLEARANCE/END PLAY

The trailer wheel and assemblies will provide many years of trouble free service if the bearings are maintained with the correct end play and the oil remains clean and uncontaminated.

Numerous resources are available on-line describing the procedure for measuring wheel end play. Industry trade association, Technology and Maintenance Council (TMC) publishes their Recommended Practice (RP) #RP618 which details the whole process. The TMC information is available at tmconnect.trucking.org.

Our standard spindle nut is the Hendrickson Precision nut; the Precision 240 on N-spindles and Precision 320 on P-spindles. See Figure 36A. Hendrickson has published a poster T71005 that details the procedure for installing and correctly setting end play in the hub using this nut system. Go to hendrickson-intl.com to get a copy of this literature.

Special tools are required to perform this end play check. Specifically, a dial indicator with a magnetic base. It is not necessary to remove the wheels to perform this check, but experience will teach that it is easier to accomplish with the wheels out of the way. Proceeds as follows:

- a. Jack up and block the axle so that the wheel end hub can be turned by hand.
- b. Drain the oil and remove the hub cap.
- c. Ensure the exposed end of the hub is clean and free of gasket material from the hub cap.
- d. Mount the dial indicator base on the exposed end of the axle, with the plunger tip against the end of the hub. Zero the indicator dial.
- e. Grasp the hub at the 3 and 9 o'clock positions. Pull on the hub while simultaneously oscillating the hub about 45 degrees. Continue to pull and stop oscillating then read the dial.
- f. Next push the hub inward while oscillating. Continue to push and stop oscillating then read the dial.
- g. The total movement of the dial indicates how much end play exists. Acceptable end play is between 0.001" and 0.005".

WARNING

DO NOT operate the trailer if any axles have improper wheel end play. This will lead to bearing failure, which in turn can allow the entire wheel/hub assembly to come loose from the axle. Such a wheel-off situation will cause damage to the equipment, but is extremely dangerous to other vehicles on the road or bystanders in the vicinity. There is a high probability of being killed if anyone should get hit by a loose and out of control rolling wheel.

If necessary to adjust end play or if the hub is removed for another reason, use the correct procedure for adjusting the wheel end play, as follows:

- a. For the Precision style nut with the lock washer, begin by removing the two screws and the interlock washer.
- b. Ensure that the hub turns freely. If it does not and there is rough, grinding or sticking action – STOP and determine WHY!
- c. Using a properly calibrated torque wrench, torque the spindle nut to 200 lb-ft while simultaneously turning the hub. This process is intended to fully seat the bearings and remove unwanted space.
- d. Back off this nut approximately one full turn.
- e. Torque the Precision nut to 50 lb-ft (68 Nm) while simultaneously rotating the hub 3 full turns.
- f. Back the nut off again and repeat this torque while rotating the hub. Hendrickson advises that this procedure must be done 4 times to fully seat the bearing and remove unwanted play or movement.

- g. Once the torque cycle has been done 4 times, back the nut off 1/6 turn (60° of rotation). This will provide the correct end play in the hub and bearings.
- h. Insert the Interlock washer and secure it with the button head cap screws. These screws on the Precision 240 nut should be torqued to 10 lb-ft (13.5 Nm). On the Precision 320 nut, the screws are larger and should be torqued to 15 lb-ft (20Nm).
- i. Check the end play as per the previous section to ensure it is within the correct range.

The Pro-Torq spindle nut, Figure 36B, is an option installed on some trailers. If your trailer is equipped with this option, the decal shown in Figure 37 will be affixed to the side of the trailer. The procedure adjusting end play with the Pro-Torq nut is as follows:

- a. Begin by removing the orange keeper ring from inside the nut. Use a screwdriver to carefully pry the keeper ring free. It is recommended that this keeper ring not be reused. Replacement parts are available from your authorized dealer.
- b. Ensure that the hub turns freely. If it does not and there is rough, grinding or sticking action – STOP and determine WHY!
- c. Using a properly calibrated torque wrench, torque the Pro-Torq nut to 200 lb-ft while simultaneously turning the hub.
- d. Back off the Pro-Torq nut until it is loose; approximately ½–1 full turn.
- e. Begin rotating the hub and simultaneously torque the nut to 100 lb-ft. Continue rotating the hub and back the nut off 1/4 turn.
- f. Install a new keeper ring by inserting the tab on the ring into the undercut groove of the nut and engage the tang into the keyway of the axle. If the inner tang does not align with the axle keyway, back off the nut slightly until it does. The orange color face of the keeper ring must be facing outward so as to be visible.
- g. Check the end play as per the previous section. This Pro-Torq procedure should consistently produce between 0.001" and 0.003" of end play.

5.5.2 - HUB CAP

Check the hub caps as follows:

- a. The transparent window, if so equipped, must remain transparent. If the window becomes bulged outward or becomes opaque (no longer transparent) this indicates excessive heat has been experienced. Excessive heat results from improperly adjusted bearing end play, inadequate lubrication or possibly brake problems. DO NOT reuse a hub cap that is damaged in this way. Determine the source of the excessive heat and have it corrected before putting the trailer back into service.
- b. Check for dents, cracks or other signs of mechanical damage. For example, if a wheel is dropped onto the hubcap while it is being removed, it is quite likely the cap will be dented and cracked.
- c. Replacement parts are available at your authorized dealer. Over torquing the fasteners used to mount the cap, typically done with an impact gun, will crack the cap near the bolt holes. Oil leaking through the crack will be the result.

**THINK SAFETY!
WORK SAFELY!**

5.6 - BRAKES

It should be self-evident that properly maintained and correctly functioning brakes are a critical element in the safe and efficient operation of any trailer. All Flat and Step Deck Trailers are built with air operated drum brakes on every axle. Figure 41 illustrates the key components that make up the foundation brakes.

These key components are:

- i. Brake Drum (not shown in Figure 41)
- ii. Brake Shoes with Friction Lining
- iii. S-cam
- iv. Slack Adjuster
- v. Brake Chambers

Recently, disk brakes have also been an available option on some trailers.

A wealth of information is available on-line regarding the servicing and maintenance of the trailer brakes. The Technology and Maintenance Council (TMC) of the American Trucking Association publishes a number of industry recommended practices (RP) related to brake maintenance. Go to tmconnect.trucking.org for more information. Similarly, Hendrickson International has published brochure #L974, Drum Brake Maintenance Procedures. Go to hendrickson-intl.com to get a copy.

5.6.1 - BRAKE DRUMS

The brake drums surround the brake shoes and are captured between the hub mounting flange and the wheels. Once the wheels are properly torqued in place the brake drum is locked into position and must turn in unison with the hub and wheels.

Prior to inspecting the brake drums remove/clean away any mud, rust or other dirt. Inspect for any cracks. If any are found, DO NOT reuse the drum. Discard it and replace with a new drum.

Inspect the friction surface inside the drum. The friction surface should be smooth and free of grooves or gouging. The maximum allowable diameter of the friction surface is embossed on the outside of the drum. Measure, the I.D. of the friction surface and ensure it is not worn beyond the maximum allowable diameter. Excessive wear beyond the maximum diameter, as well as heat cracking or checking or grooves worn into the friction surface are all causes dictating that replacement is needed.

We do not recommend turning, boring or resurfacing of brake drums. New brake drums are readily available at your authorized dealer.

5.6.2 - BRAKE SHOES AND FRICTION LINING

The brake drums must be removed to properly inspect the brake shoe linings.

Inspect the linings for wear. The friction surface should be smooth and continuous and without grooves or ridges. Look for signs of excessive heat such as cracking or chunks broken out. Any such damage will be cause to replace the shoes. The shoes and lining are not repairable and must be replaced. If the lining is worn down such that it has less than 1/4" of material left at any point, it is time to replace the shoe/lining.

The procedure for replacing the brake shoes is beyond the scope of this manual. Your authorized dealer has qualified mechanics available to perform this work.

5.6.3 - S-CAM

The S-cam is an important element in brake actuation. The S-cam must remain in good condition in order for the brakes to work properly. However, the inspection of the S-cam and its supporting bearings are beyond the scope of this manual. We recommend that your authorized dealer be engaged to inspect this part of the brakes. Any repairs that are necessary will be carried out by a qualified mechanic.

**THINK SAFETY!
WORK SAFELY!**

5.6.4 - SLACK ADJUSTERS & BRAKE CHAMBERS

In accordance with federal regulations, all trailers are factory equipped with self-adjusting slack adjuster. From the factory, we install Haldex S-ABA slack adjusters on all axles. These slack adjusters need little maintenance, but require grease at the prescribed interval, as outlined in the earlier Service section.

We strongly recommend that visual/operational checks be performed on the slacks at each regular inspection. Detailed information on how to perform this inspection is available from the Technology and Maintenance Council (TMC) of the ATA in their Recommended Practice RP609. Similarly, Haldex also publishes inspection and acceptance criteria for their S-ABA slack adjusters. Go to haldex.com to get a copy of this information.

One key measurement that must be checked regularly is the brake stroke as measured at the slack adjuster clevis pin. Performing the measurement will require an assistant and can be done as follows, with a tractor connected:

- a. The stroke measurement must be done when air tank pressure is between 90–100 psi.
- b. Chock the wheels so the trailer cannot roll.
- c. Ensure the emergency/parking brakes on the trailer have the air applied and are released.
- d. Measure the distance from the face of the brake chamber to the centre of the clevis pin on the slack.
- e. Have the assistant make a full service brake application at between 90–100 psi and hold it.
- f. Again measure the distance from the face of the chamber to the centre of the clevis pin.
- g. The difference between these two dimensions is the power stroke measurement for that slack. See Figure 38.
- h. These measurements must be taken at each individual slack on the trailer.
- i. If any slack demonstrates a travel in excess of allowable limits it means something is worn out or something is broken in the foundation brake. See Table B. Have it repaired by a qualified mechanic.

WARNING

DO NOT operate a trailer that has brake slacks that are outside acceptable limits. This lack of brakes will cause a dangerous situation on the road, increase stopping distances and may lead to an accident due to the inability to stop the unit. Have out-of-adjustment brakes inspected and fixed by a qualified mechanic before putting the trailer back into service. Standard stroke brake chambers must have maximum 2.0" of travel at the clevis pin. The optional long stroke chambers may have up to 2.5" of travel at the clevis pin.

A few service related tips, noted below, will improve the life of the slack adjuster.

DO NOT manually adjust the slacks. If they stop adjusting automatically have a qualified mechanic investigate and repair.

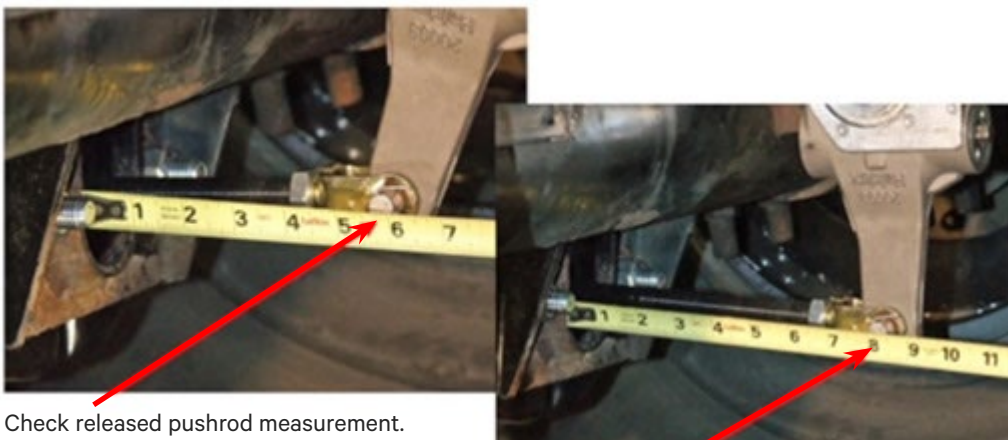

Check released pushrod measurement.

Check applied pushrod measurement at 90–100 psi. Subtract these two values. The difference is the stroke measurement.

Figure 38 – Haldex Slack Travel Measurement

CHAMBER MODEL	CHAMBER MAX POSSIBLE TRAVEL	LEGAL LIMIT OF TRAVEL AT THE SLACK
3030 Standard Stroke	2 ½"	2"
3030 Long Stroke	3"	2 ½"

Table B

Grease the slacks at scheduled intervals.

DO NOT use moly-disulfide grease on the slacks as it may affect the function of the internal friction clutch.

DO NOT over grease.

All brake chambers installed on Flat and Step Deck Trailers are Haldex 3030 chambers. They are industry standard double chambers with the service brake portion of the chamber near the pushrod end and the emergency spring brake portion at the other end. Every chamber comes equipped with a caging bolt.

As with the slack adjusters, a great deal of information regarding brake chambers is available at the TMC website. Similarly Haldex provides information at haldex.com.

The brake chambers are designed to provide approximately 1/2" more travel of the pushrod than the limit of the slack adjuster movement as described in the previous section. Table B summarizes these dimensions.

The Haldex chambers are equipped with an ORANGE ALERT band on the pushrod. See Figure 39. When this orange band becomes visible outside the face of the chamber it means the brakes are out of adjustment. Have this problem looked into by a qualified mechanic. **DO NOT** operate the trailer while any of the brakes are out of adjustment.

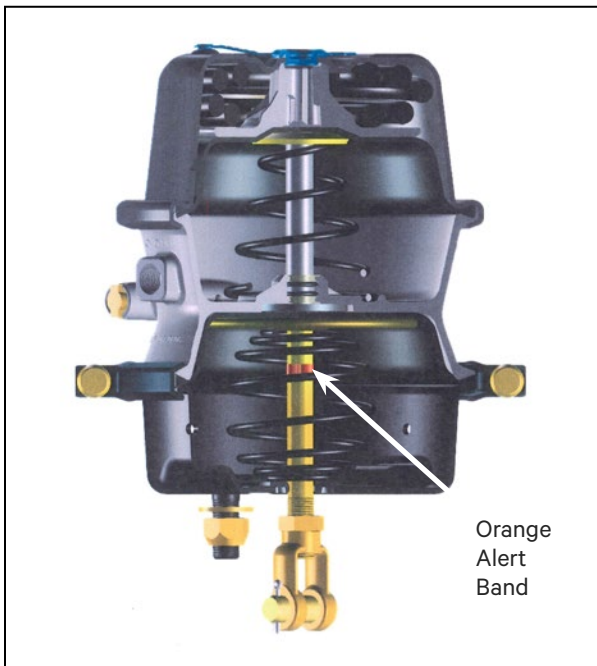

Figure 39 – Brake Chamber

! DANGER

The emergency brake portion of the chamber houses a very powerful compression spring. Attempting to service or disassemble the chamber can result in explosive release of the components inside the chamber. Serious personal injury or even death can result. Have a qualified mechanic deal with any issues that arise with the brake chambers.

5.6.5 - ANTI-LOCK BRAKE SYSTEM

Each Flat and Step Deck Trailer comes factory equipped with an Anti-Lock Brake System (ABS). We use Meritor Wabco ABS systems. This system will typically have either two or four wheel speed sensors, one at each end of the centre axle. The ABS valve is tank mounted. Air lines run from the valve to the brake chambers.

Detailed information on operation and maintenance of the ABS is available from Meritor Wabco at wabco-na.com/product/ABS.

The ABS is an electronically controlled system that monitors wheel rotation speed and controls this speed during braking. If the wheel speed sensor detects brake lock-up the computer activates the modulator valve to control the air pressure and prevent the lock-up. A status light for the ABS is located at the roadside rear corner of the trailer. See Figure 40. During normal operation of the ABS, the status light will illuminate momentarily when power is first applied and then go off. If the status light comes on and stays on it means the ABS computer has detected a fault in the system and requires maintenance attention. In the event of a system fault, the brake system still functions as a regular air brake system without the anti-lock function.

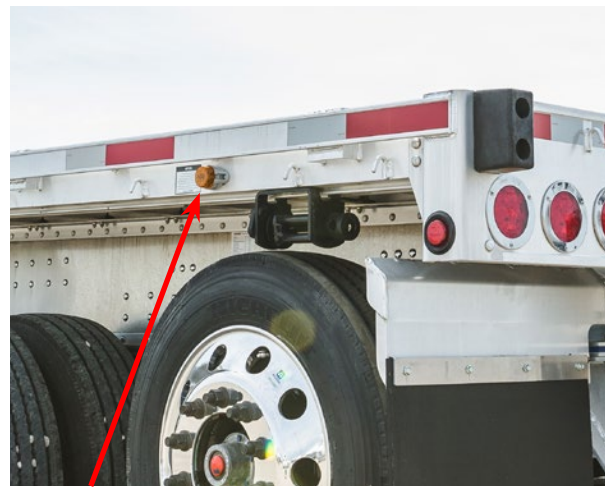

Figure 40 – ABS Status Light

CAUTION

DO NOT operate a trailer with faulty ABS. Have a qualified mechanic diagnose and repair the system. Operating the trailer without functioning ABS may result in loss of control of the unit during braking, leading to an accident.

**THINK SAFETY!
WORK SAFELY!**

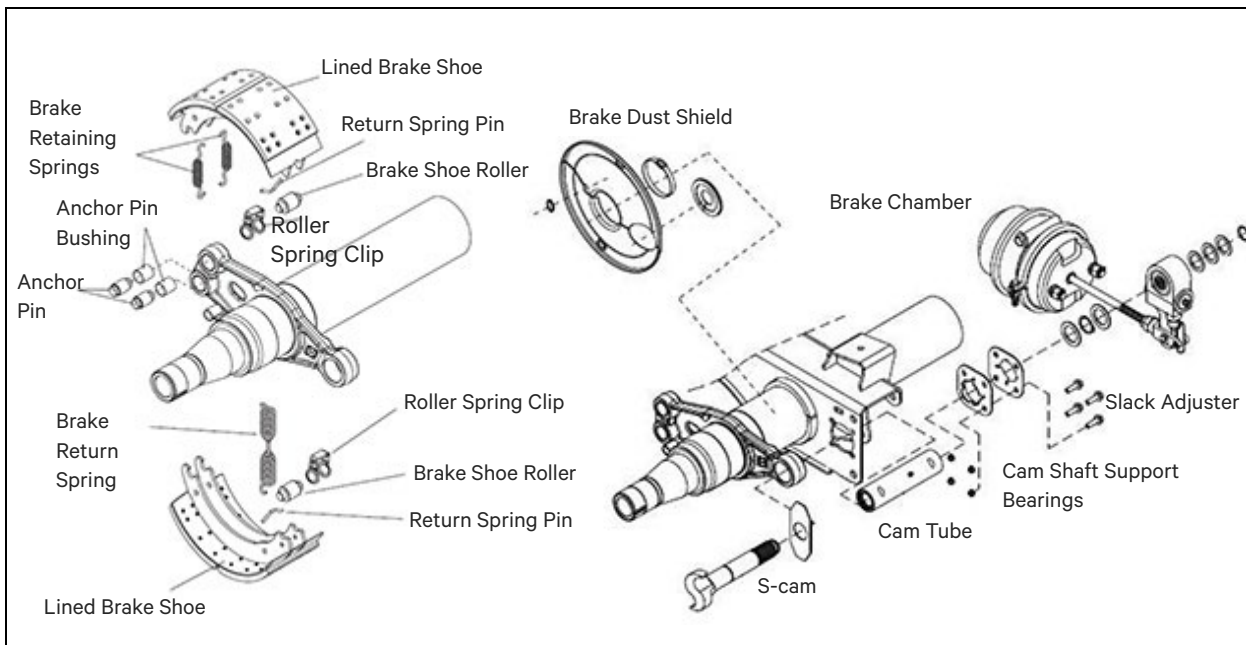

Figure 41 – Typical Brake Component Identification

5.7 - WHEELS AND TIRES

Your Flat and Step Deck Trailer is equipped with 10-stud, hub piloted wheels. Most units use aluminum wheels although steel wheels are an available option.

Installing the wheels correctly on each axle and properly torquing all 10 lug nuts on each wheel end is critically important to keep the nuts tight. Keeping the lug nuts tight at all times is the way to avoid a wheel-off incident while travelling on the road.

WARNING

Wheel lug nuts must be retorqued during the trailer's first trip, within 100–150 km (60–100 miles) of operation. This practice must be repeated any time a wheel is removed and reinstalled. Failure to retorque may lead to loose wheels, possibly resulting in a wheel-off condition and serious injury or even death to the operator or bystanders.

5.7.1 - WHEEL NUT RETORQUE PROCEDURE

The industry standard terminology of “retorquing” wheel nuts may be slightly misleading. In carrying out this procedure we are, in fact, simply verifying that the existing wheel nuts were correctly torqued when they were installed and that they remain tight. This procedure will also identify any wheel nut that is loose, bringing it up to the prescribed torque value.

Each trailer is provided with the decal shown in Figure 42. It is very important that the operator read and understand this procedure for torquing the wheel lug nuts.

The procedure for checking the wheel nuts at a retorquer is as follows:

- a. Assuming you are using a “click” style torque wrench, set it in the range of 465–485 lb-ft.
- b. Place the torque wrench on the first lug nut. Apply force to the handle of the wrench until it “clicks” to indicate the wrench has reached the prescribed torque. STOP!
A single click is all that is required.
- c. At the prescribed torque value the lug nut should NOT move. If the nut does turn, even a little bit, it means it is not adequately tightened. In this event continue to apply force on the wrench and keep tightening the nut until it

achieves the correct torque and the wrench “clicks”. STOP!! As above, a single click is all that is required.

NOTE

If the nut turns while checking, do not stop at that point. Rather, keep the force on and keep tightening until you get the click. This action must be done in one continuous, smooth action.

- d. Move to stud #2 following the sequence on the decal shown in Figure 42. Repeat step A through C above.
- e. Check all the remaining studs in the correct sequence.
- f. If any nuts were found loose, ie. they turned during checking and were retorqued, go back and recheck the torque once again to make sure the wrench “clicks” without the nut moving.

NOTE

If the nut still turns when going back to double-check, or if it wants to keep turning while trying to retorquer, it means the stud/nut is damaged. Either the thread on the fastener are being torn off or the stud has been over torqued previously and stretched to the point of failure. DO NOT put the trailer back into service until this failure is investigated and corrected.

WARNING

All 10 studs are necessary on each wheel end and they must be correctly torqued to achieve adequate clamping force to hold the wheels securely on the axle. DO NOT operate trailer with an incomplete set of wheel studs and nuts.

NOTE

DO NOT over torque the wheel lug nuts. The prescribed torque, as per Figure 42, will produce the maximum possible clamping force the stud is capable of delivering. By over torquing you reduce the actual clamping force produced and there is a good chance you will damage the stud and/or thread.

! WARNING

Nut Tightening Sequence
8 and 10 Hole Systems

Failure to follow these instructions may result in wheel loss, which can lead to property damage, injury or death. Refer to the product service of owner's manual for additional information.

This vehicle is equipped with hub-piloted disc wheels, flange nuts, and **M22 x 1.5** studs. Tighten to 50 ft-lbs torque in the sequence shown and then torque to **450-500 ft-lbs oiled*** using the same tightening sequence. Retorque between 50-100 miles after installation and at each regularly scheduled service interval.

*Oiled- Apply two drops of oil to a point between the nut and flange and two drops to the two or three threads at the end of each stud.

Walther EMC 3501 Shotwell Drive Franklin, Ohio Phone: 937-743-8125

Figure 42 – Hub-Piloted Torque Sequence

The procedure here assumes the wheel nuts are being checked for torque. If, however, you are reinstalling a set of wheels it is necessary to add some steps to this procedure, as outlined in Section 5.7.3 following.

! WARNING

Before tightening the lug nuts on the wheel it is critically important to visually check that the brake drum is fully seated against the mounting flange of the hub and located on the hub pilots. If the brake drum should become jammed or slightly cocked off to one side it may leave a gap between the drum and the hub. When the nuts are torqued to the specified amount, the studs will actually bend the face of the drum and prevent the studs from achieving their full clamping force. See Figure 43 & Figure 44. A lug nut tightened in this circumstance will not stay tight, likely resulting in a wheel-off situation. A wheel-off situation can easily lead to serious damage to the equipment, but more importantly, can seriously injure or even kill the operator or other bystanders.

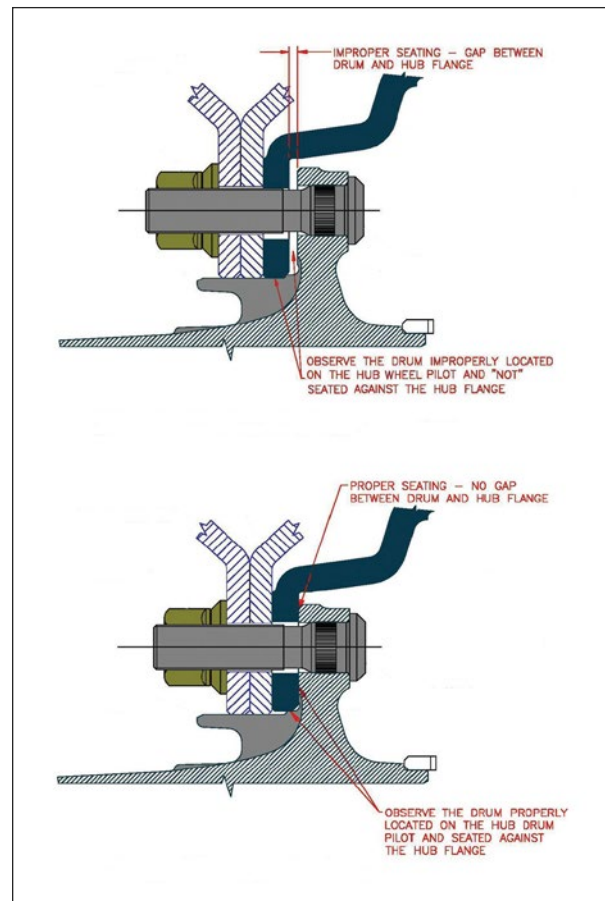

Figure 43 – Properly Seated Brake Drum

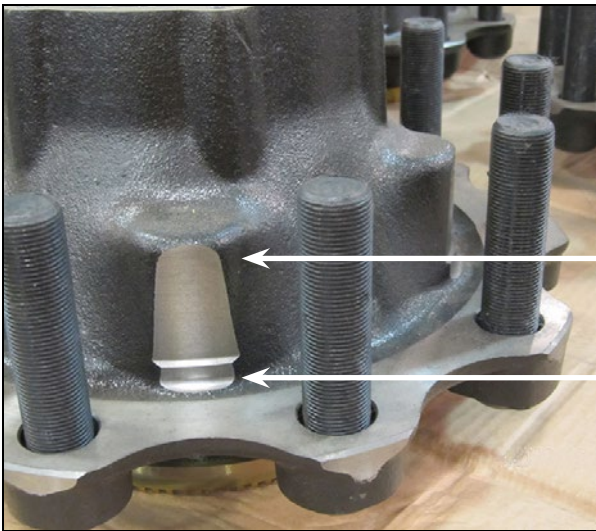

Figure 44 –Hub Pilots

Wheel Pilot

Brake Drum Pilots are slightly
Larger in Diameter

5.7.2 - TIRES

1. **Tire Care and Maintenance:**

Although this subject appears to be a simple one, nevertheless, it has been established that through neglect, tires wear fast or fail early. Even with the best of maintenance, the service that tires deliver is largely in the hands of the driver. Careless driving habits can result in serious tire damage and shorten the life of a tire. Tire care and maintenance is relatively simple, takes little time and pays off.

2. **Tire Inspection:**

A regular inspection of the tires is the first step in increasing tire mileage. These inspections will help to spot troubles, such as under-inflation, over-inflation and mis-alignment early. Minor damages, that may be repaired, can be detected at these inspections and save a tire that would otherwise blow out.

Inflate tires to manufacturer's recommended pressures. Proper inflation costs nothing, but will increase tire mileage. Under-inflation causes abnormal wear at the side of the tread because the outer edges of the tire carry the load, while the centre tends to flex up away from the road. This causes the tire to run hotter.

Tires found to be under-inflated before operation should be returned to the proper pressure. Over-inflation causes abnormal wear in the centre of the tread, also shortening the life of the tire. This is caused because the centre of the tire tread carries more than its share of the load. Check for correct pressure when tires are cool. When a tire is in use it becomes heated and subsequently could exceed maximum rated tire inflation pressure.

Over-inflation reduces the ability of the tire to absorb ordinary shock and causes fabric or tread separation, or both, resulting in tire failures. Over-inflation will not compensate for overloading. An over-inflated tire is more vulnerable to snags, cuts and punctures.

NOTE

The cold tire inflation pressure shown on the trailer VIN plate corresponds to the tire manufacturers recommended inflation pressure that matches the Gross Axle Weight Rating (GAWR) of the trailer. However, this GAWR tire pressure may not be optimum for your operation. Consult the tire manufacturers literature on their website to learn what tire pressure is best for the work your trailer does.

3. **Mechanical Irregularities:**

Brakes that are out of adjustment, or out-of-round brake drums will contribute to rapid and spotty tire wear. Improper brake adjustments will lead to spotty tire wear in several places, while out-of-round drums will usually wear in a single spot. Improperly adjusted or worn wheel bearings can lead to uneven tire wear. Also improper axle alignment and worn suspension pivot bushings will cause excessive tire wear.

4. **Radial Tire Application:**

Radial and bias ply tires should not be “mixed” either in dual combination or on the same axle except in an emergency situation. “Mixing” on the same dual combination, although the tires match by diameter, will result in uneven wear because of the different flexing characteristics.

5. **Matching Tires to Wheels:**

When mounting tires on wheels, be sure the right tires are used on the right wheels. Many tire failures can be traced to not having matched the tires and wheels properly. In most cases there is a preferred and an alternate wheel width for the popular tire sizes. The preferred widths are recommended as they provide the optimum rim to tire ratio. Refer to manufacturers recommendations. Check the trailer VIN data to learn the size of tires and wheels your trailer left the factory with.

The tires of each wheel must be matched to within 1/8" of the same rolling radius (1/4" of the same rolling circumference) under normal loading conditions. The tires should have equal pressures.

6. **Hub Piloted Wheels:**

When removing wheels for maintenance:

- a. Clean and lube protruding studs before nut removal.
- b. Coat the wheel piloting pads with a light engine oil or penetrating oil before reinstallation of wheel.

5.7.3 – TIRE CHANGING PROCEDURE

- a. Precautionary Notes:
 - i. Keep unnecessary personnel away when raising and lowering trailer and changing tire.
 - ii. Do not crawl under a raised trailer.
 - iii. Do not leave a raised trailer unattended.
 - iv. Avoid raising a loaded trailer whenever possible.
- b. Position trailer on a level, hard surface capable of supporting the total vehicle weight and lifting equipment.
- c. Set brakes and block wheels at other locations to prevent movement.
- d. Make sure air ride suspensions are inflated and an air source is available to maintain inflation.
- e. If a loaded trailer must be raised for changing tires, take appropriate precautions to reduce risk of tipping, load shifting, or structural damage, including: Use two lifting devices and raise both sides of the trailer evenly to prevent leaning.

NOTE

Ensure the parking brakes are engaged. It is best to keep the tractor or B-Train connected to the trailer while changing tires.

- f. Position the jacks or lifting devices under the axle, as close to the outer end as possible. Use care to avoid placement that will cause contact and damage to other components such as brake chambers, cam shafts, U-bolts, and slack adjusters.
- g. Before the weight is lifted off, break all 10 lug nuts loose.

**THINK SAFETY!
WORK SAFELY!**

- h. Raise the trailer at a slow, steady rate until the tires to be removed are off the ground. If using two lifting devices, raise both sides of the trailer evenly to avoid leaning and tipping.
- i. Position trailer supports under trailer frame or axle to prevent unexpected lowering of the trailer.
- j. Clean and lube protruding lug nuts, and remove. Remove tire using adequate lifting device.
- k. After both wheels are removed, clean the hub and studs to remove dirt or rust. Visually inspect the threads on the studs for damage. Ensure the brake drum remains firmly and properly seated on the hub.
- l. Lubricate the piloting pads with a light motor oil or penetrating oil.
- m. Install the replacement tire/wheels.
- n. Torque the securing nuts to the 50 ft-lb value specified in the decal shown in Figure 42, to snug the wheels in place.
- o. Remove trailer supports.
- p. Lower trailer to the ground at a slow, steady rate. If two lifting devices are used, lower both sides evenly to avoid leaning and tipping.
- q. Final torque the securing nuts to 475 Ft-lb following the sequence on the decal in Figure 42.
- r. Remove lifting devices and check wheel nuts to ensure they are torqued to the specified values.
- s. Remove blocks from wheels.

NOTE

Do Not attempt to lift a loaded trailer with a single lifting device located at the center of an axle.

5.7.4 - WHEELS

Your trailer may be equipped with either steel or aluminium wheels. Check for damaged (bent) and loose wheels. Studs, bolts and nuts must be checked regularly.

We install only hub-piloted wheels on the Deck Trailer. Ensure they are correctly installed and seated as outlined in Section 5.7.1.

Replace any wheel that is bent, cracked, worn or otherwise damaged.

CAUTION

Wheel nut torque must be checked within the first 100–150 km (60–100 miles) of operation following installation. Failure to do so may lead to loose wheels and result in loss of wheels and personal injury. See Section 5.7.1.

CAUTION

Nuts must be kept tight by retorquing nuts on a routine basis and using the proper torque and tightening sequence. Loose nuts could result in loose wheels or premature wheel failure. This can result in an accident or injury.

5.8 - AIR SYSTEM COMPONENTS AND SCHEMATICS

 **MAINTENANCE SAFETY**

1. Always block vehicle wheels. Stop engine when working under a vehicle. Depleting vehicle air system pressure may cause vehicle to roll. Keep hands away from chamber push rods and slack adjusters; they may automatically apply as system pressure drops.
2. Never connect or disconnect a hose or line containing air pressure. It may whip as air escapes. Never remove a component or pipe plug unless you are certain all system pressure has been depleted.
3. Never exceed recommended air pressure and always wear safety glasses when working with air pressure. Never look into air jets or direct them at anyone.
4. Never attempt to disassemble a component until you have read and understand recommended procedures. Some components contain powerful springs and injury can result if not properly disassembled. Use only proper tools and observe all precautions pertaining to use of those tools.
5. Use original manufacturer replacement parts and components.
 - a. Only components, devices, mounting and attaching hardware specifically designed should be used.
 - b. Replacement hardware, tubing, hose, fittings, etc. should be of equivalent size, type, length and strength as the original equipment.
 - c. Make certain that when replacing tubing or hose, all supports, clamps or suspending devices that were originally installed by the vehicle manufacturer are reinstalled.
6. Devices with stripped threads or damaged parts should be replaced. Repairs requiring machining should not be attempted.
7. Repairs should be performed only by a qualified mechanic

**THINK SAFETY!
WORK SAFELY!**

Pressurized air is supplied to the system by the tractor and provides power to release and operate service and parking brakes. The air system schematic shown in Figure 45, Figure 46, and Figure 47 below shows the layout of the air system used on the Flat and Drop Deck Trailers. The system and valves must be inspected and functionally checked on a regular basis to insure proper operation. However, in most cases it will be beyond the scope of this manual to provide repair instructions. Have a qualified mechanic perform any repairs that may be necessary.

IMPORTANT

The air system works best when clean, dry air is supplied from the tractor. Equipping the system with a dryer and filter pays rich dividends by reducing contamination and subsequently maintenance requirements.

The air brake system is comprised of:

- Gladhands
- In-line filter
- Accelerator valve
- Valves (Tank Mounted)
- Air-Lines – service brakes and supply air
- Air tanks
- Hoses and Brake Chambers

The most effective preventative maintenance for the air system is to maintain a clean dry supply of air. Dirt and moisture promote corrosion in the brake system, leading to maintenance problems and failures.

In support of this objective, it is important to regularly drain any moisture that may collect in the air tanks. This procedure is presented earlier in the operation section of this manual.

Aside from clean dry air there are no components in the air system that require a specific maintenance procedure. There are no points to lubricate.

Preventative maintenance consists of:

- Clean the air filter, as presented earlier in Section 5.2 Number 3.
- Visually inspect the gladhands, all lines, valves and tanks for corrosion or signs of damage. Have any such damage repaired.
- Check for system leaks. Repair any that are found.

These checks and inspections should be carried out every three months; 40,000km (25,000mi); 900 operating hours or while performing chassis lubrication.

⚠ CAUTION

The manufacturers of air system valves strongly recommend avoiding the use of air line anti-freeze. These products contain some form of alcohol or methylhydrate which attacks and deteriorates the O-rings, seals and plungers in the valves, causing premature failure of these items.

At each yearly safety inspection an operational and leakage test should be carried out. The Technology and Maintenance Council (TMC) of the American Trucking Association (ATA) has published a detailed Recommended Practice (RP) to be followed in performing this test.

It is presented here as follows:

OPERATIONAL AND LEAKAGE TESTS

Check the tractor dash gauge against a gauge known to be accurate before performing these tests. Connect the tractor air lines to the trailer on which the spring brake valve is to be tested. Block all wheels or hold the vehicles by means other than air brakes.

1. Install a gauge in the trailer reservoir(s). Build tractor and trailer to full system pressure by placing the park control valve and the trailer air supply valve in the charge position. As system pressure reaches approximately 75–95 psi, the trailer spring brakes should also build up to approximately 75–90 psi before the reservoir(s) begin to charge.

2. When full system pressure is reached, and the spring brakes are fully released, apply a soap solution to the spring brake valve exhaust port and the vent. A one inch bubble in five seconds is permissible.
3. Place the trailer air supply valve in the exhaust position. The spring brakes should apply. Disconnect the trailer supply line and soap the hose coupling to check for leaks. A one inch bubble in five seconds is permissible.
4. Reconnect the trailer supply hose coupling and recharge the trailer system. The spring brakes should release. Shut off the engine. Open the trailer reservoir drain cock. The tractor air system should bleed down to approximately 70 psi. The trailer spring brakes should remain released. After the system is stabilized, leakage at the open drain cock should not exceed a one inch bubble in five seconds.
5. If the spring brake valve does not function as described or if leakage is excessive, have a qualified mechanic repair the problem.

All of the nylon synflex air lines on the trailer are color coded to match the system as follows:

- | | |
|--------------------|--------------------------------|
| Blue Lines | Service Brakes |
| Red Lines | Supply/Emergency Brakes |
| Black Lines | Air Ride Suspension |
| Green Lines | Tire Inflation System |

**THINK SAFETY!
WORK SAFELY!**

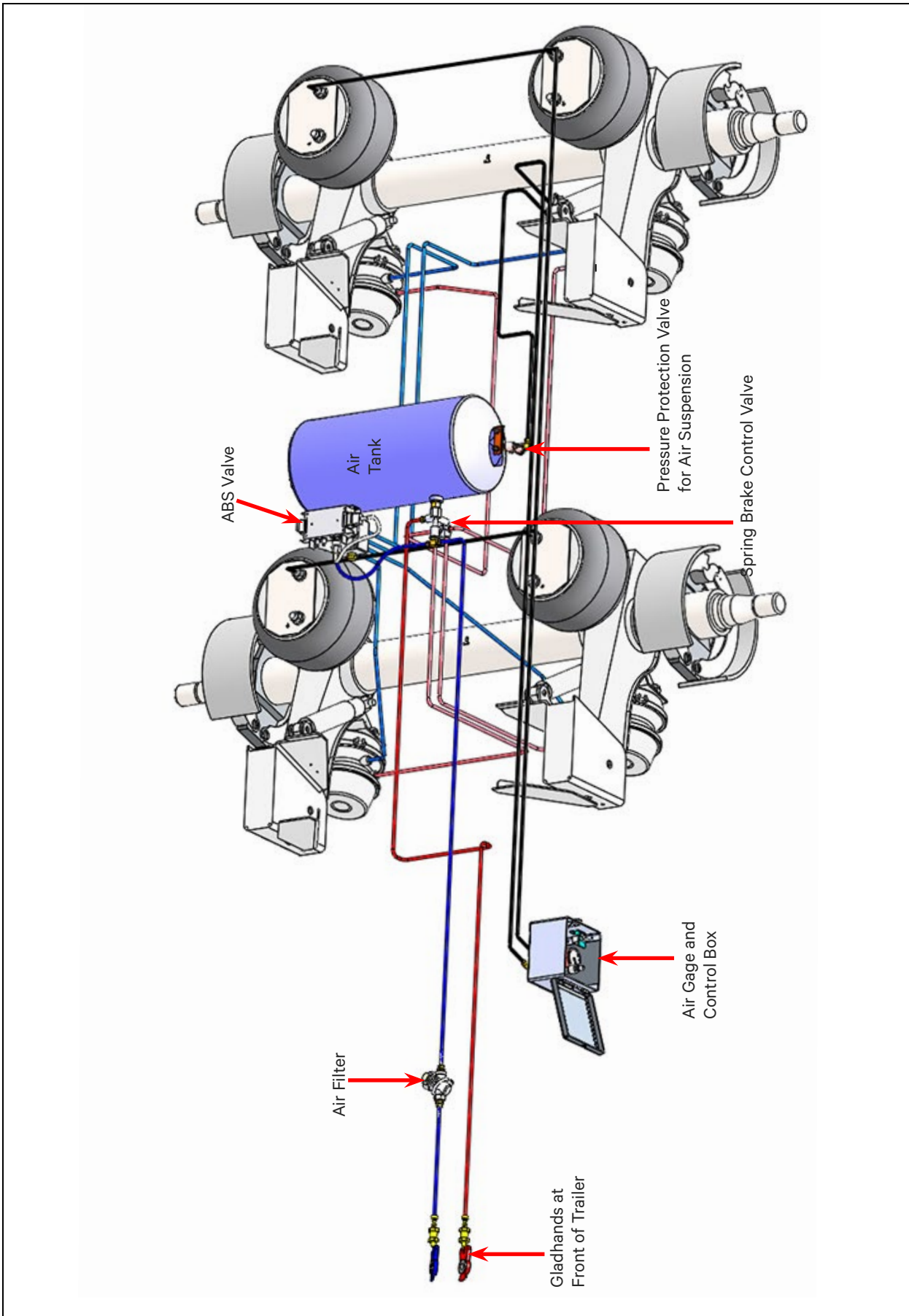

Figure 45 – Tandem Axle Pneumatic System

SECTION 5 - SERVICE AND MAINTENANCE

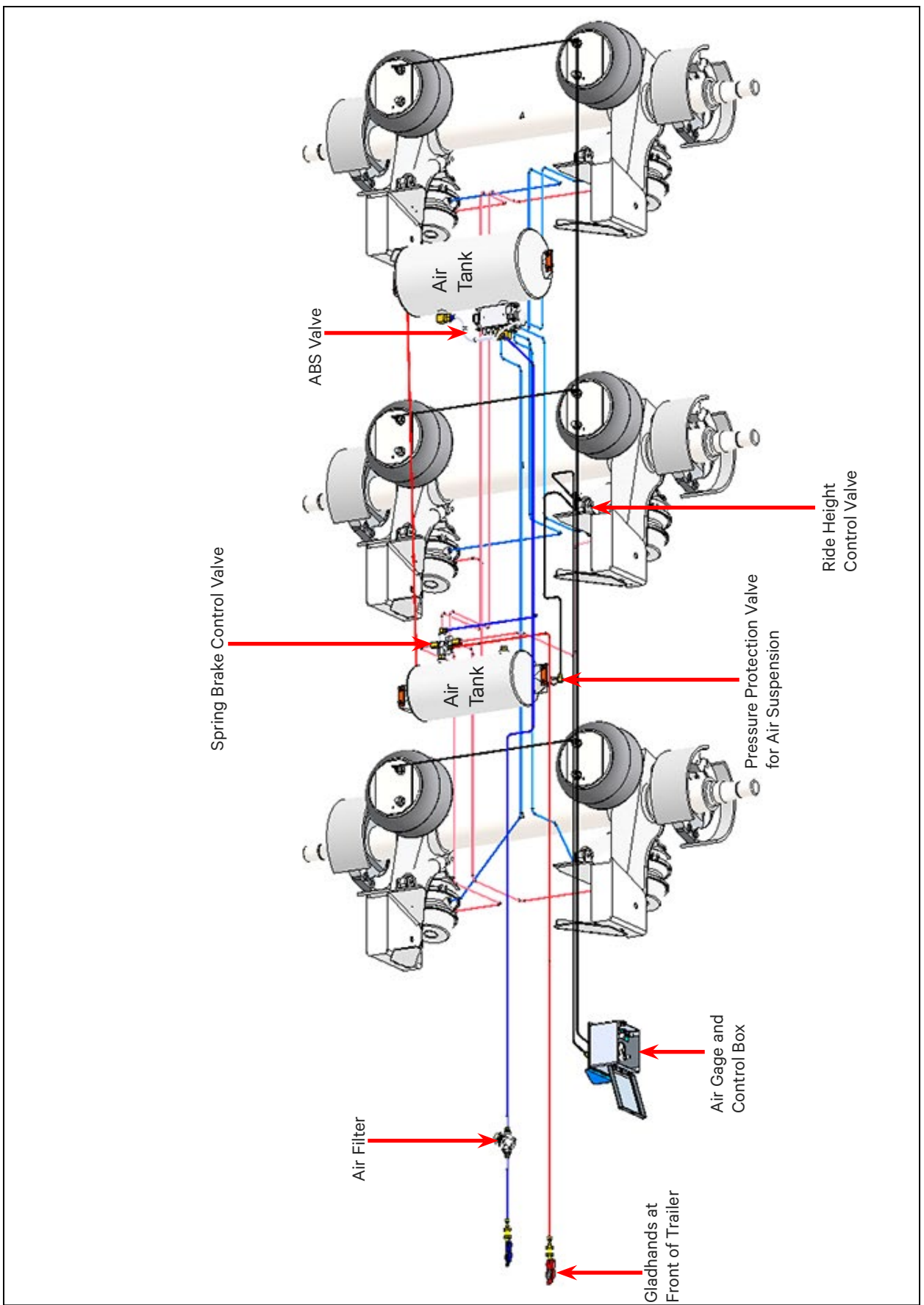

Figure 46 – Tridem Axle Pneumatic System

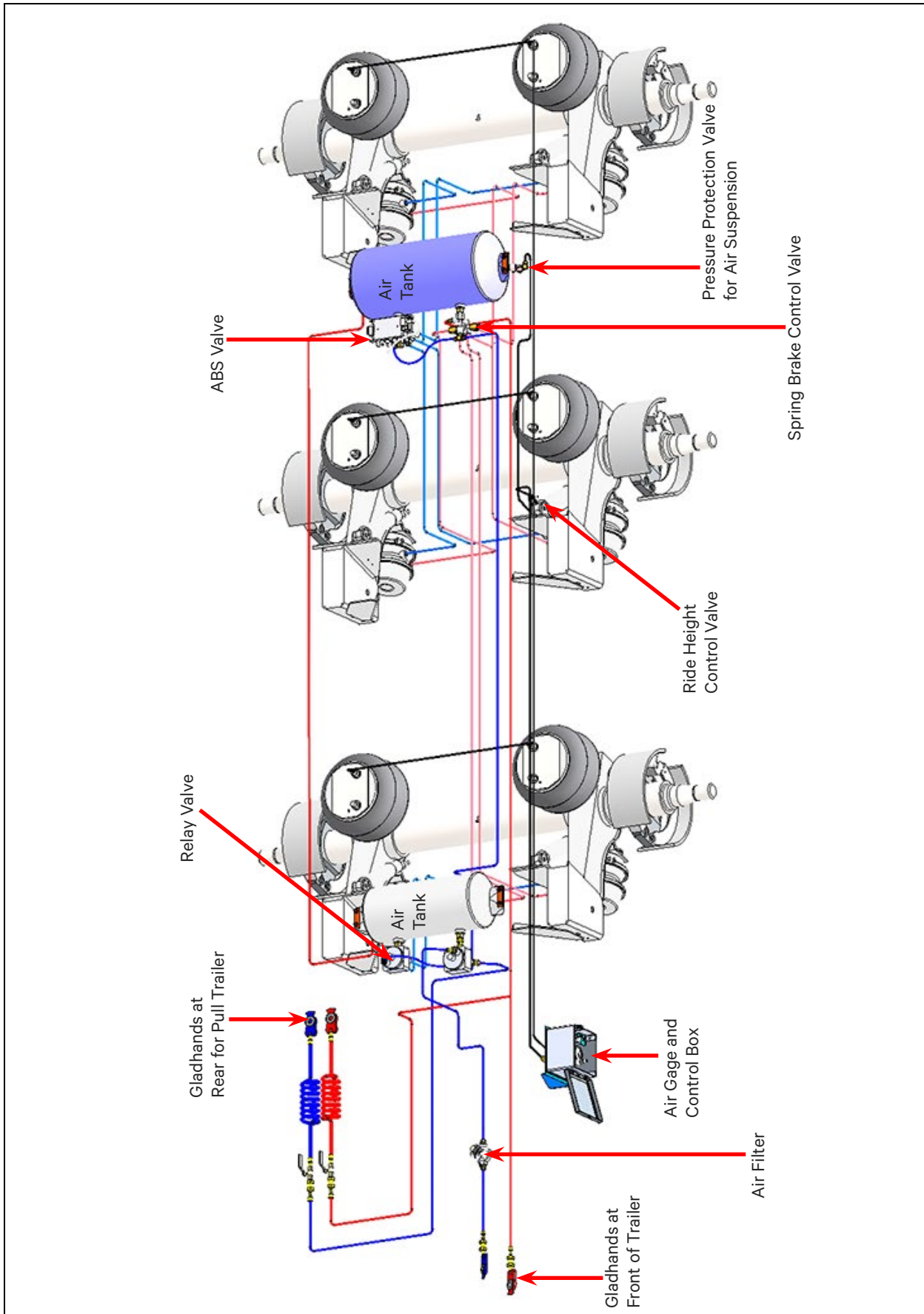

Figure 47 – B-Train Lead Pneumatic System

5.9 - ELECTRICAL SYSTEM

All of our semi-trailers are equipped with an electrical system comprised of six (6) circuits and one ground wire. Hence a 7-pin nose plug is used to connect electrical power from the tractor. The 7 wires in the main wire harness are color coded as shown in Figure 48.

As with the air system, there are also no items in the electrical system that require any maintenance procedure. Each daily pre-trip inspection should have identified burned out or damaged lights. Replace any such damaged lights.

Corrosion is one of the most common causes of electrical problems. Dielectric grease is applied at the factory where the lights are plugged into the wire harness. This grease is intended to provide a seal to keep moisture out. During the trailer's annual safety inspection, inspect the wiring system for any signs of damage to the wire insulation.

Remove all lights and reapply dielectric grease to all terminals and reinstall lights. All systems are to be checked prior to operating the unit. Lenses, reflective and identification devices should be kept clean. The operator should on a periodic basis, during night operation, have someone verify there are no lights flickering or momentary outages indicating loose connections, light bulbs or lens problems. More attention should be given to this when operating on rough road conditions.

**THINK SAFETY!
WORK SAFELY!**

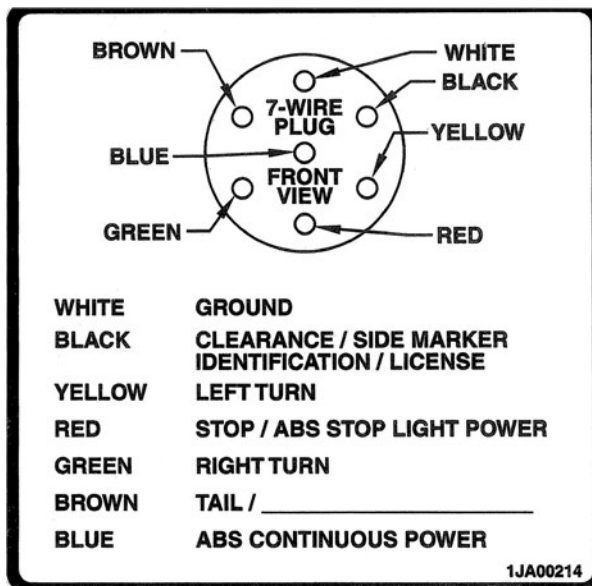

Figure 48 – Wiring Schematic Color Code

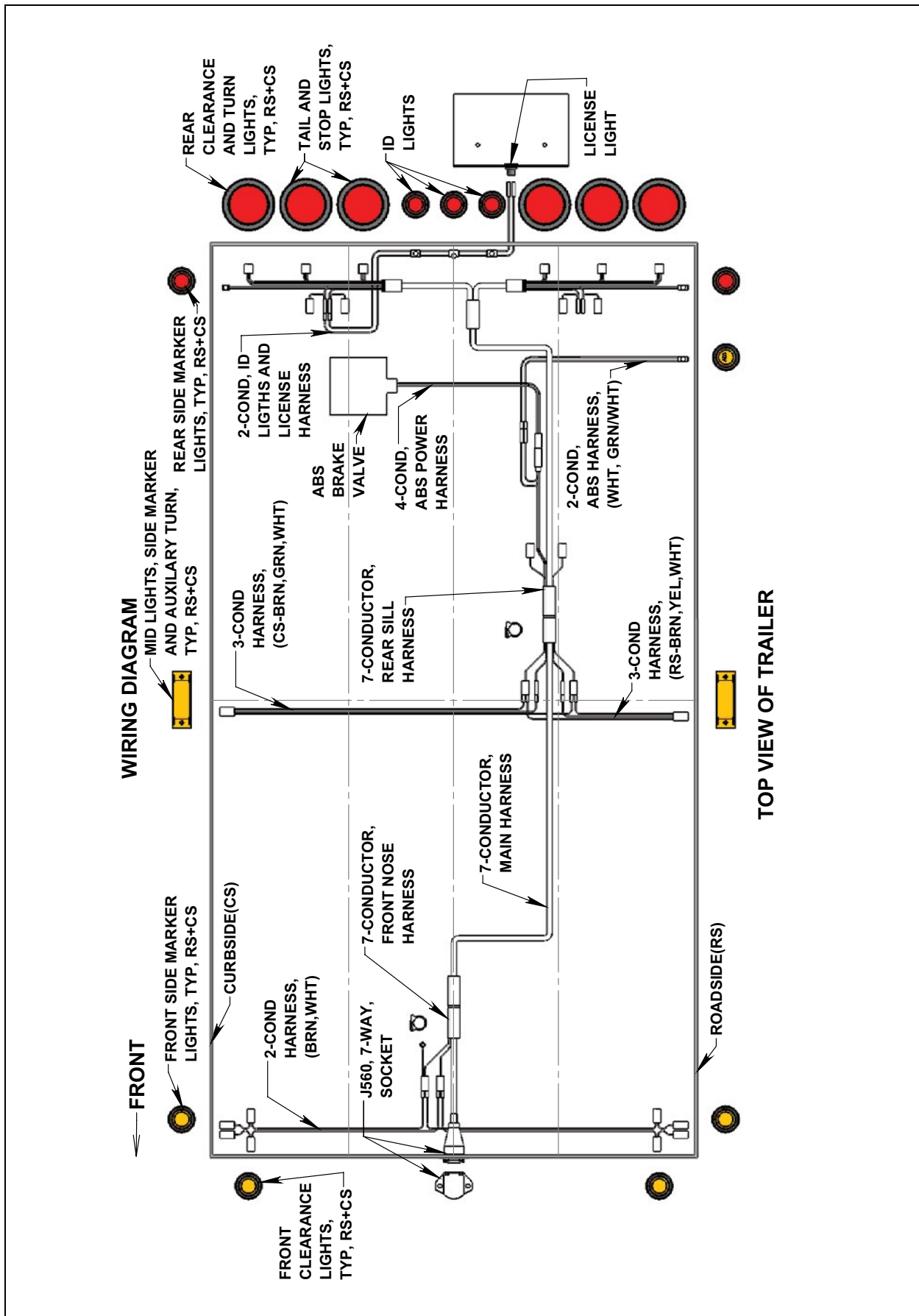

Figure 49 – Electrical System Schematic

5.10 – FIFTH WHEEL ON LEAD

IMPORTANT

All maintenance must be performed while the trailer is uncoupled from the Fifth Wheel.

NOTE

All of the following must be performed every 50,000 km (30,000 miles) or 3 months, whichever comes first.

1. Inspection – General:
 - a. Thoroughly clean the entire area using steam or pressure washer.
 - b. Inspect the fifth wheel mounting. Check bolt torque and replace any missing or damaged bolts. Check for broken or distorted components and repair or replace as needed.
 - c. Inspect the fifth wheel assembly for bent, worn or broken parts. Replace with original manufacturers parts only.

2. Fifth Wheel Mechanism – Inspection and Adjustment:
 - a. Verify operation by opening and closing locks with Holland Kingpin Lock Tester model no. TF-TLN-1000 or TF-TLN-5000.
 - b. Check the adjustment of the fifth wheel locks and adjust as required. Use the following procedure for the appropriate locking mechanism. If the locks cannot be properly adjusted due to wear, the fifth wheel should be rebuilt or replaced. Contact your dealer to order the appropriate rebuilding kit or new fifth wheel. Have a qualified mechanic perform necessary repairs.

WARNING

DO NOT use any fifth wheel which does not operate properly.

WARNING

Improper adjustment can cause improper locking of the mechanism.

3. Adjustment – Locking Mechanism:
 - a. Close locks using Holland Lock Tester.
 - b. Rotate rubber bushing located between the adjustment nut and casting.
 - c. If the bushing is tight, rotate nut on yoke shank counter-clockwise until bushing is snug, but still can be rotated.
 - d. Verify proper adjustment by locking and unlocking with the lock tester.

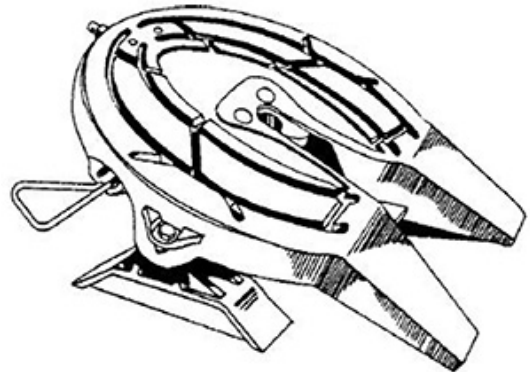

Figure 50 – Fifth Wheel

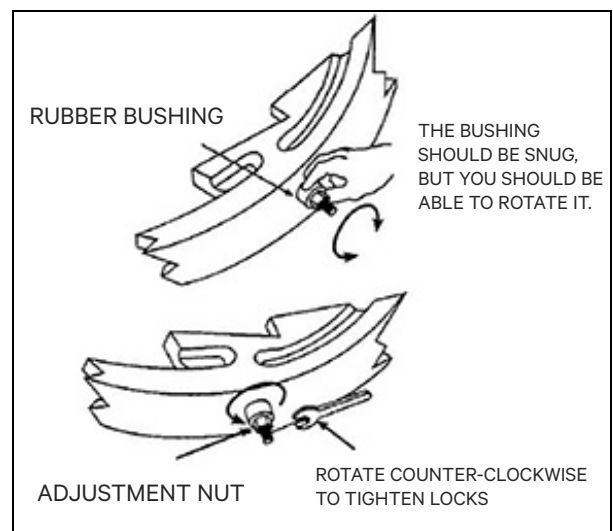

Figure 51 – Adjustment – Locking Mechanism

5.11 - PAINT FINISH

HOW TO MAINTAIN AND CARE FOR THE FINISH ON YOUR NEW FLAT OR STEP DECK TRAILER

The Axalta Imron Elite System® provides superior protection against the elements your trailer will face throughout its life. To make sure you maximize the benefits of the Axalta Imron Elite System®, use the following guide to take care of your finish.

- Wash your vehicle often, especially when exposed to salty, dusty, acidic or alkaline environments.
- When washing your vehicle, use commercially available car wash soaps, specifically designed for washing cars. These soaps are non-abrasive and have a neutral pH (non acidic or alkaline) detergent. DO NOT use solvent-based solutions for washing large areas.
- During the first 30 days when the finish is still fresh, clean the vehicle with water rinse only. Pressure washers used when paint is still fresh could affect the finish. Avoid high pressure and or high pressure too close to areas that have stone chips visible on fresh paint.
- DO NOT wash vehicle using extremely hot water or pressure while the surface is hot.
- (DO NOT wash vehicle in the hot sun.)
- Avoid washing with stiff bristles. Soft cloth and felt brushes are recommended. Avoid machine type automated washing systems.
- DO NOT allow spilled gasoline, anti-freeze, hydraulic fluid, or windshield washer fluid to stand on the paint – remove immediately by rinsing with water.
- DO NOT wax for the first 60 days.
- Ice and snow should be brushed, not scraped off.
- Have any paint nicks or scratches repaired as soon as they occur to protect against corrosion.
- Should your trailer finish become damaged, have it repaired as soon as possible. Specify the Axalta Imron Elite System® used for the original finish. This will assure you the best possible color match and the same durability and appearance as when your trailer was new.

PREVENTATIVE MAINTENANCE SUMMARY

COMPONENT	FREQUENCY	INSPECTION
Kingpin	25,000 miles (40,000 km) or every 3 months.	Kingpin wear and no damage to anchoring structure.
Axle Components		
Wheel Bearings	25,000 miles (40,000 km) or every 3 months.	Bearing condition and tightness. Wheels turn smoothly without roughness or sticking.
Oil in Hub	Daily.	Check oil level. NOTE: The wheel ends do not consume oil. If the oil level on any hub begins to drop it means something is leaking. Find the problem and have it repaired.
Brake Linings	25,000 miles (40,000 km). 100,000 miles (160,000 km).	Check lining wear. Reline as required.
Brake Slack Adjusters	50,000 (80,000 km) or yearly	Check that the travel of slack adjusters is within limit.
Wheels	As required. 25,000 miles (40,000 km).	Check for cracked or bent wheels. Check for loose, missing, broken, stripped or otherwise ineffective wheel studs and lug nuts. Retorque lug nuts after removal and replacement according to Section 5.7.1.
Wheel Lug Nuts	Weekly	Check for security. Retorque as per Section 5.7.1.
Tires	As required	Alignment to Chassis. NOTE: Axles out of alignment will usually manifest themselves in the form of irregular tire wear patterns.
Suspension		
Air Ride.	Also see Section 5.4. Every 3–6 months.	Hardware tightness. Mechanical damage. Check for correct ride height setting.

PREVENTATIVE MAINTENANCE SUMMARY (CONTINUED)

COMPONENT	FREQUENCY	INSPECTION
Air Systems		
Air Tanks	Daily	Drain air tanks.
Glad Hands.	Daily.	Look for cracks, worn or damaged components. Replace as required.
Air Filter	Monthly	Clean cartridge
Spring Brake Valve	Every 3–6 Months	Perform operating and leakage tests
Service Brake Valve (ABS valve)	Annually or 100,000 miles (150,000 km)	Perform operating and leakage test.
Air Line/Hoses	Daily	Check for leaks, chafing, kinking, or other mechanical damage.
Pilot Relay Valve (if equipped)	Annually or 100,000 miles (150,000km) whichever comes first.	Repair or replace as required.
N.B. Replace or repair any components as required.		

TROUBLE SHOOTING

PROBLEM	PROBABLE CAUSE	CORRECTIVE ACTION
Fifth wheel lock does not fully engage.	Worn parts.	Check fifth wheel locking adjustment. (See Maintenance Section)
	Mechanism mis-adjustment.	Check for excessive wear.
	Dirt or gravel contamination.	Wash and inspect.
Excessive or uneven tire wear.	Over- or under-inflation	Inflate to proper pressure.
	Loose wheel nuts.	Tighten wheel stud nuts.
	Loose wheel bearing.	Adjust bearings.
	Axle bent or out of alignment.	Align axles. If axle is bent see your dealer.
	Tires not properly matched.	Match tires.
	Improper acting brakes.	Correct brakes as required.
	Rapid stopping.	Apply brakes slowly when approaching stops.
Scuffed tires.	Over or under inflation.	Inflate to proper pressure.
	Excessive speed on turns.	Reduce speed.
Wobbly tires.	Worn or damaged wheel bearings.	Replace bearings.
	Broken or bent wheel or rim.	Replace wheel or rim.
	Bent axle.	See your dealer.
	Broken wheel studs.	Replace wheel studs.
Dog tracking.	Bent axle.	See your dealer.
	Frame or suspension (axles) out of alignment.	Straighten frame or align axles.
	Worn or damaged suspension pivot connection or bushings.	Check and replace.

TROUBLE SHOOTING

PROBLEM	PROBABLE CAUSE	CORRECTIVE ACTION
Loss of tire pressure.	Puncture in tire.	Repair or replace tire.
	Faulty valve or valve core.	Replace valve assembly or core.
	Wheel damage.	Replace wheel.
Brakes do not apply evenly.	Brake valve(s) not operating correctly.	Check brake adjustment and related items.
	Loading of trailer not proportional.	Redistribute loads.
	Faulty auto slack adjuster.	Replace auto slack.
Brakes do not release.	Gladhands connected backwards.	Connect gladhands correctly.
	Brake hoses restricted.	Replace hoses.
	Brake out of adjustment.	Adjust brakes.
	Damaged brake assembly.	Replace damaged parts.
	Contaminated air valves.	Clean or replace.
No brakes or insufficient brakes.	Source of air supply shut off at tractor.	Open cutout cocks at rear of tractor cab or push control valve "IN".
	Disconnected or not properly coupled glad hands.	Connect or properly couple glad hands.
	Low brake line pressure.	Check air pressure gauge on tractor-inoperative compressor.
	Brake pads worn or glazed.	Replace pads.
	Reservoir drain valve open.	Close drain valve.
Grabbing brakes	Oil, grease or foreign material on brake lining.	Repair leaking wheel seal and reline brakes.
	Brakes out of adjustment.	Adjust brakes.
	Brake drum out of round.	Replace brake drum.
	Damage brake chamber or internal assembly.	Replace complete brake chamber.
	Leaky or broken hose between valve and brake chamber.	Replace or repair as required.

SECTION 7 – TROUBLE SHOOTING

PROBLEM	PROBABLE CAUSE	CORRECTIVE ACTION
ABS light on continuously.	A fault has been stored in system.	Requires service from qualified tech.
Brakes dragging.	Brakes set too tight.	Adjust brakes (slack adjuster).
	Binding cam, anchor pins or chamber rod end pin.	Lubricate and free up.
	Diaphragm leaking in brake chamber.	Replace brake chamber.
	Air valve contamination.	Clean or replace.
	Damaged brake assembly or brake drum out of round.	Replace.
Slow brake application or release	Lack of lubrication.	Lubricate brake operating parts.
	Excessive travel in brake	Adjust brakes; Repair worn out parts if necessary.
	Restriction in hose or lines.	Repair or replace.
	Defective brake valve(s).	Replace defective valve(s).
All air springs flat.	Insufficient air supply.	Build up and maintain tractor air pressure at least 85 psi. Check couplings and valves from tractor to trailer.
	Leak or broken air line in trailer or air suspension system.	Inspect and test for leaks, repair.
	Malfunctioning height control valve.	Inspect, test and replace as required.

PROBLEM	PROBABLE CAUSE	CORRECTIVE ACTION
One air spring flat.	Air spring leaking or punctured. Restriction in hose or lines.	Replace air spring. Repair or replace.
Air suspension deflates rapidly when parked.	Leak air system.	Locate and repair leak(s).
Trailer rides too high or too low.	Improperly adjusted height control valve. Control valve linkage broken and disconnected.	Check height and readjust height control valve. Inspect and repair or replace linkage.
Excessive shock absorber wear.	Defective height control valve. Damaged air spring.	Replace valve. Replace air spring(s).
Height control valve not functioning.	Dirt or foreign matter in air supply line.	Check and clean air filter. Inspect, clean or replace height control valve.
Dim or flickering lights.	Battery on tractor not sufficiently charged. Bad connection. Damaged wire in jumper cable. Poor ground at sockets.	Charge battery. Check electrical system circuits. Repair or replace cable. Repair as necessary.
Complete loss of trailer lights.	Broken main harness. Frayed wires. Broke/damaged jumper cable. Loose or corroded connection in ground lead between tractor and trailer(s).	Repair or replace. Check circuit breaker at front. Replace jumper cable. Repair or replace.

INDEX

INDEX	70	SERVICE AND MAINTENANCE	33
INTRODUCTION	1	Air System Components and Schematics	55
OPERATION GUIDELINES	15	Brakes	46
Break-In	18	Anti-Lock Brake System	48
Coupling & Uncoupling Procedures	21	Brake Drums	46
Coupling Procedure – Tractor to Trailer or Lead to Pull	21	Brake Shoes and Friction Lining	46
Uncoupling Procedure	23	S-cam	46
Uncoupling the Pull	24	Slack Adjusters & Brake Chambers	47
Flip-Over Beavertail Ramps	31	Alterations to the Trailer	34
Loading/Unloading the Trailer	24	Electrical System	60
Loading/Unloading	25	Fifth Wheel on Lead	62
Load Location and Securement	25	Kingpin and Upper Coupler	36
Load Rating	24	Paint Finish	63
Load Securement	26	Suspension and Axles	36
Pre-Operation Vehicle Inspection Procedure	19	Air Bags	41
Principle Components	16	Axle Alignment	39
To the New Operator or Owner	15	Control Valve	41
Transporting	27	Fasteners	40
Braking Guidelines	27	Pivot Connection	36
Operating Instructions	27	Ride Height Setting	36
Run-empty Axle Lifts	30	Shock Absorbers	41
Tire Inflation System	29	Trip Servicing	35
Tires	28	Wheel Ends	42
PREVENTATIVE MAINTENANCE SUMMARY	64	Hub Cap	45
SAFETY	2	Seals	42
Loading Safety	4	Wheel Bearing Clearance/End Play	44
Maintenance Safety	4	Wheels and Tires	50
Operating Safety	3	Tire Changing Procedure	53
Reporting a Safety Defect	6	Tires	52
Safety Signs	4	Wheel Nut Retorque Procedure	50
Sign-Off Form	5	Wheels	54
Travel Safety	4	TROUBLE SHOOTING	66
SAFETY SIGN LOCATIONS	7		

